

Particle dynamics and nongyrotropic velocity distribution functions in magnetic reconnection

Seiji ZENITANI

Kobe University

Acknowledgement: T. Nagai, I. Shinohara (JAXA/ISAS)

T. Wada (NAOJ)

Magnetic reconnection in near-Earth space

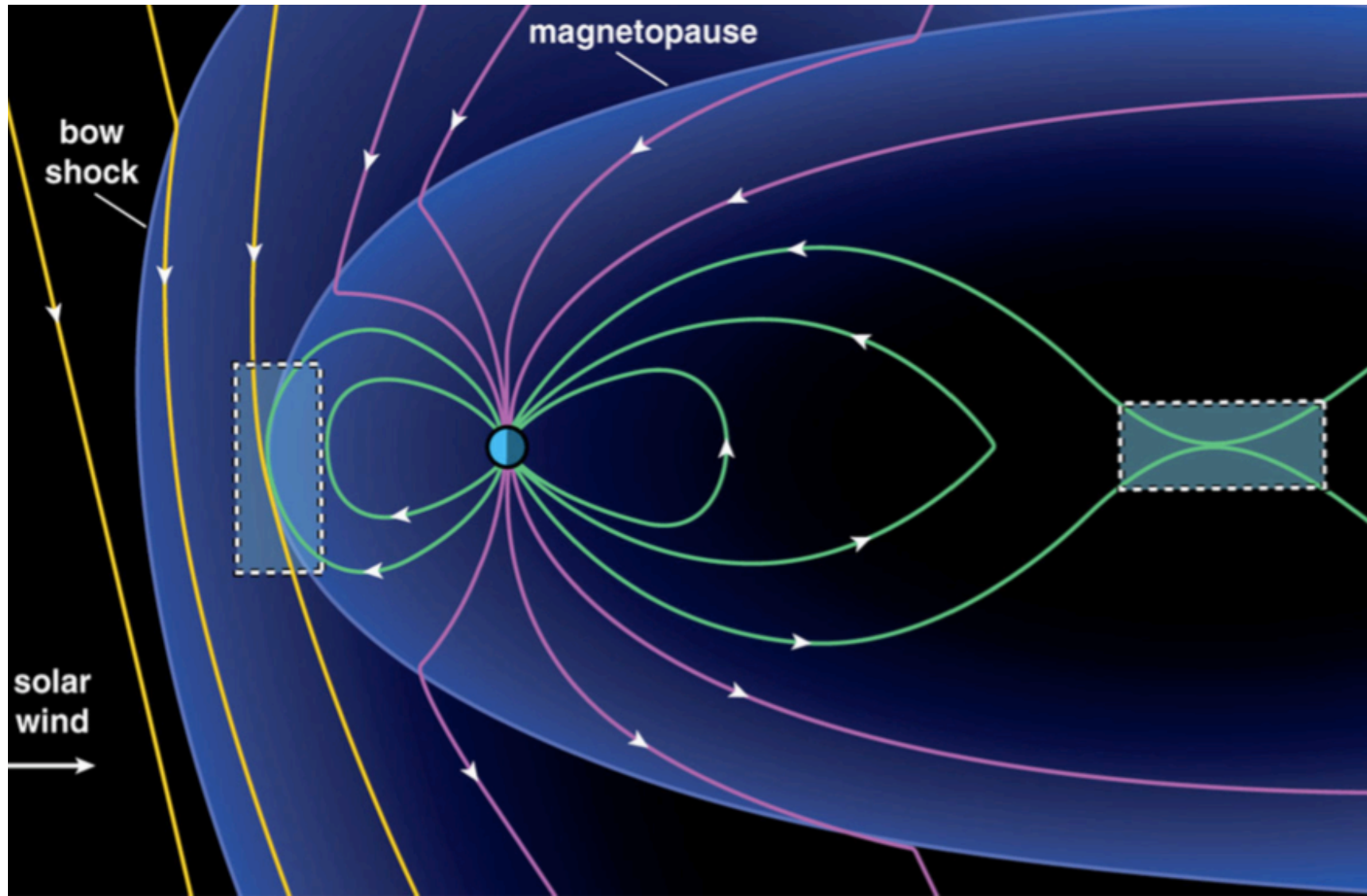

Velocity distribution functions (VDFs)

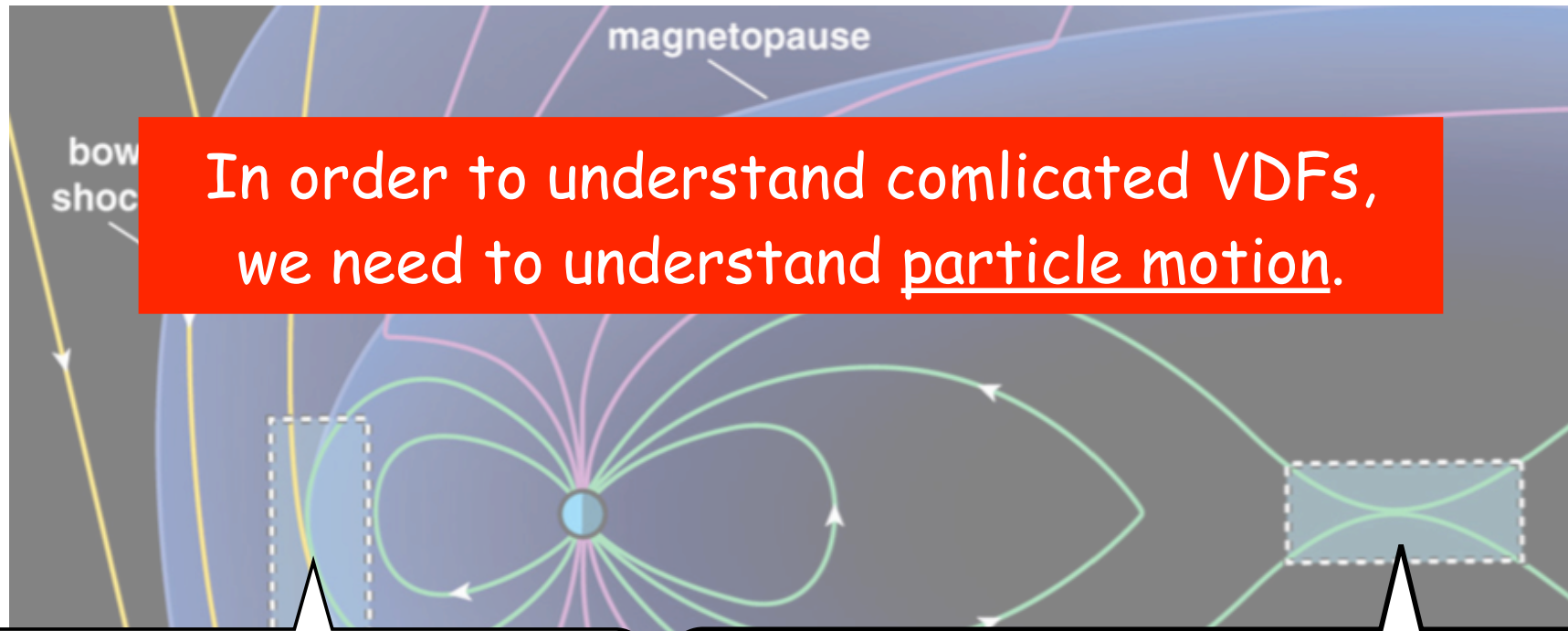

In order to understand complicated VDFs, we need to understand particle motion.

Magnetopause

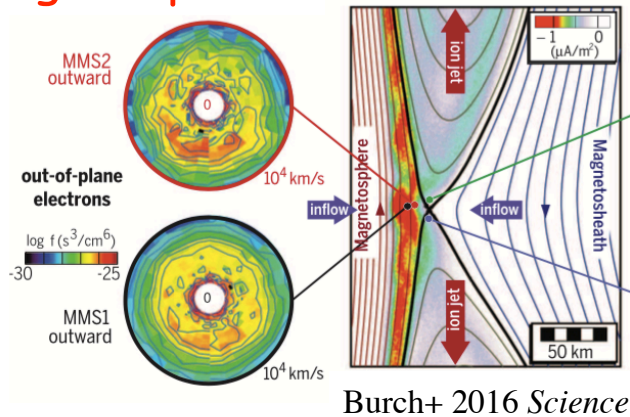

Magnetotail

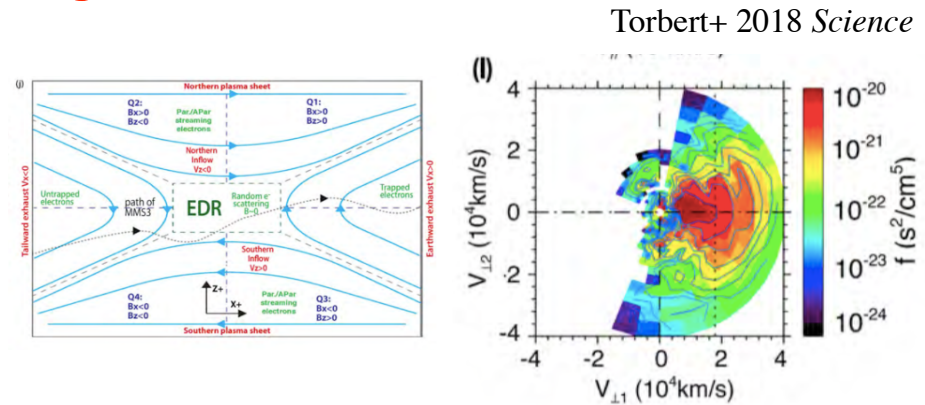

Today's agenda

1. Particle motion in a reconnected geometry
2. Ion motion and VDF in the outflow exhaust
3. Electron motion around the reconnection site

1. Particle motion in a reconnected geometry
2. Ion motion and VDF in the outflow exhaust
3. Electron motion around the reconnection site

Notes

- I employ the GSM-like coordinates
- Signs are sometimes opposite, because figures/equations are taken from my ion/electron papers

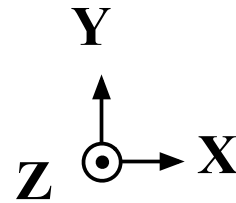
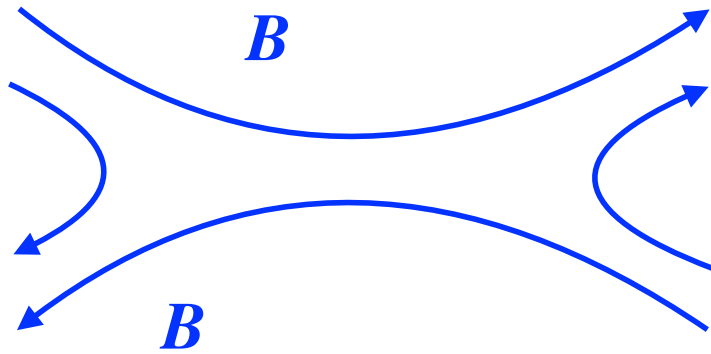

- Simulation coordinates

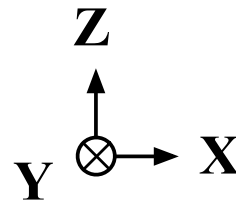

- GSM/GSE-like coordinates
- Magnetotail

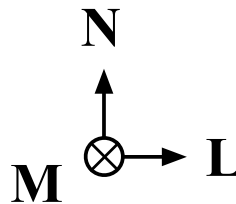

- LMN coordinates
- Magnetopause, foreshock

Meandering motion

- Partial gyration about $+\mathbf{B}_0$
- Partial gyration about $-\mathbf{B}_0$

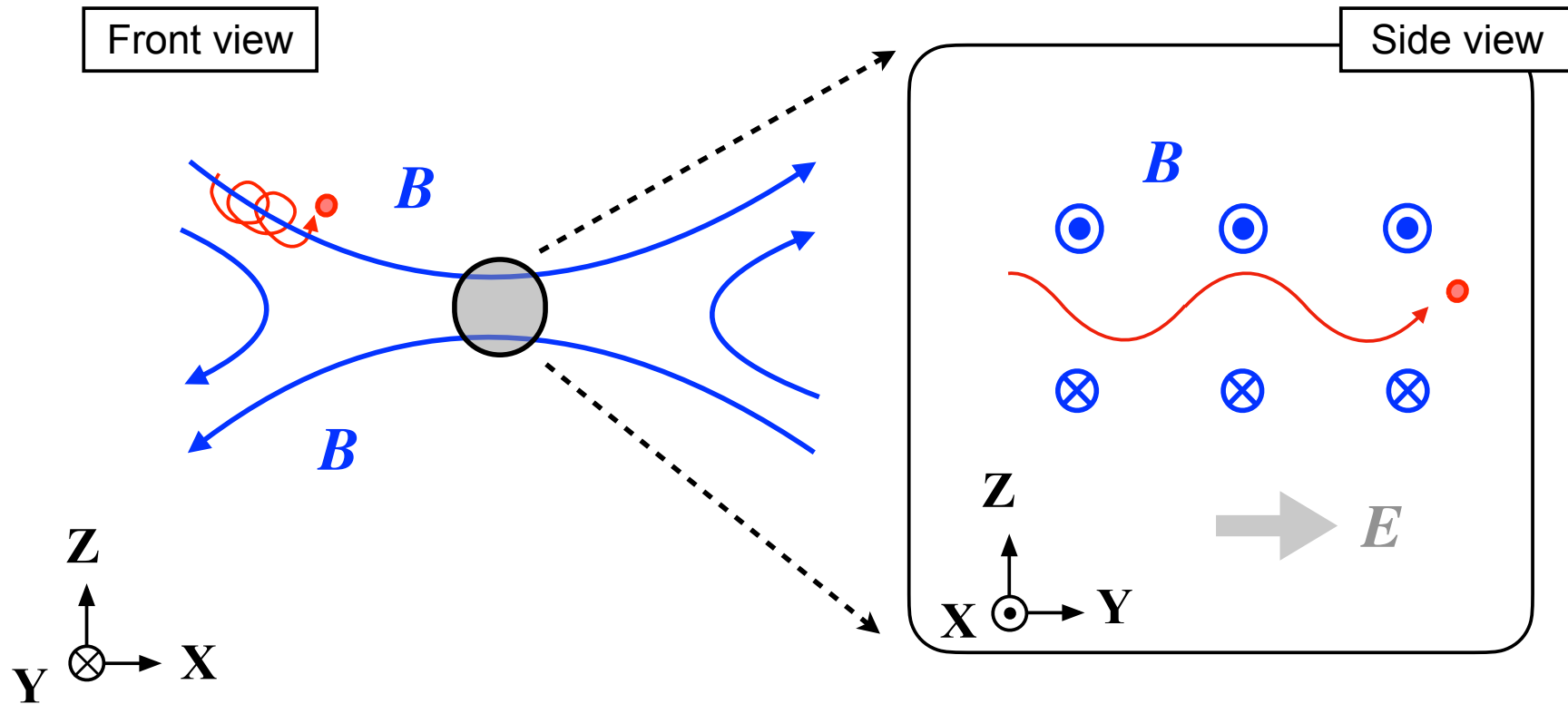

Meandering ions

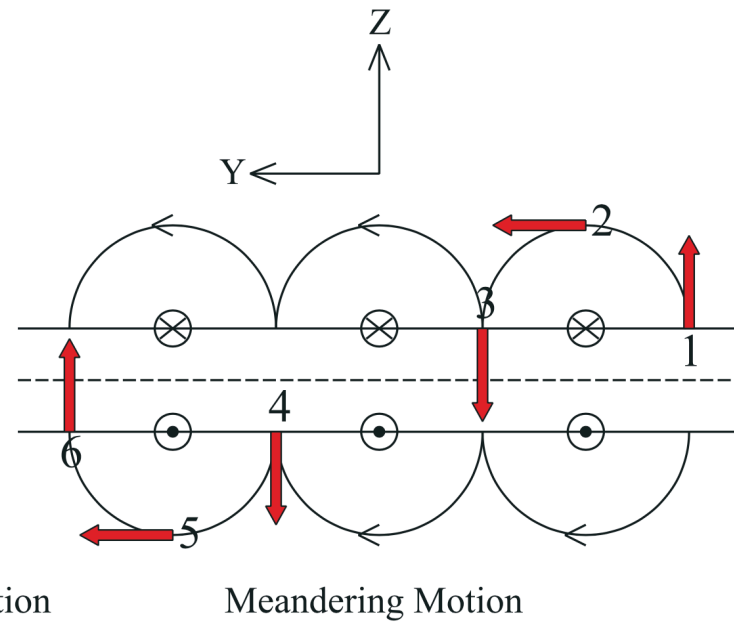
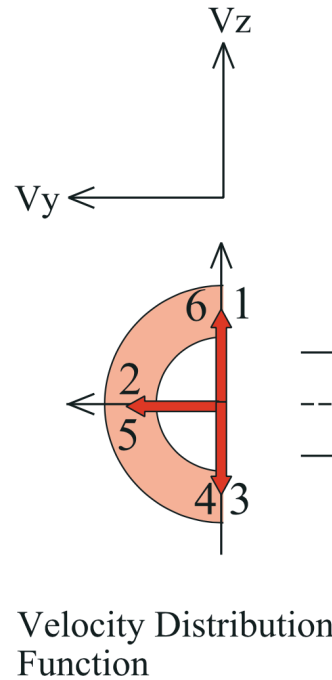
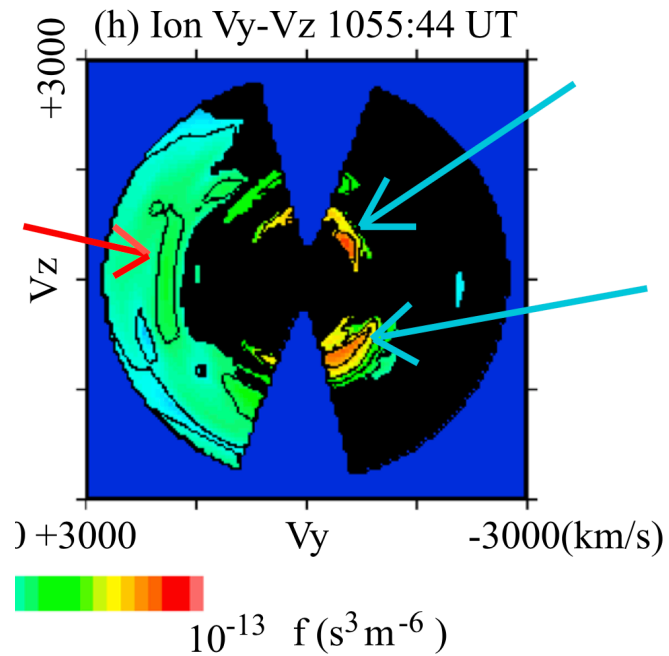

- Meandering ions are confirmed in Geotail observations of magnetotail reconnection

Speiser motion

- Meandering motion + slow gyration about \mathbf{B}_n

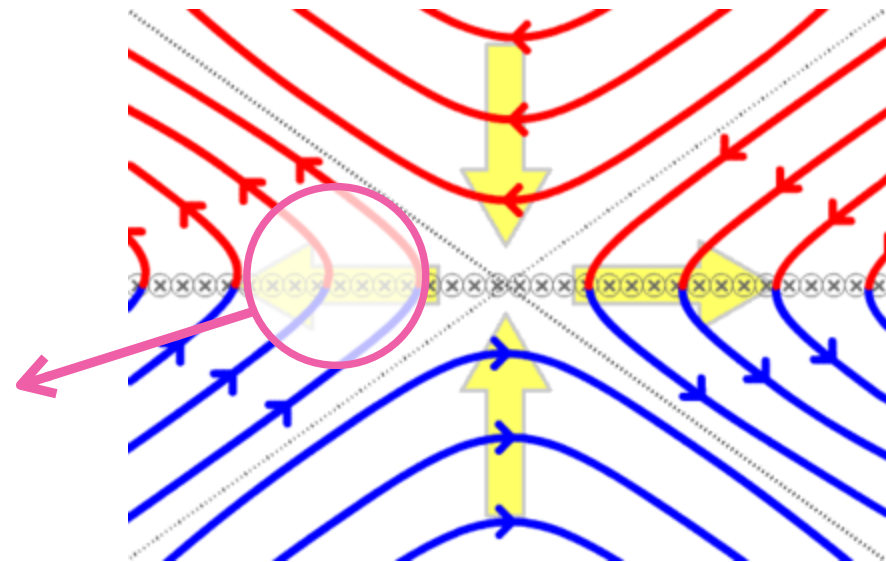
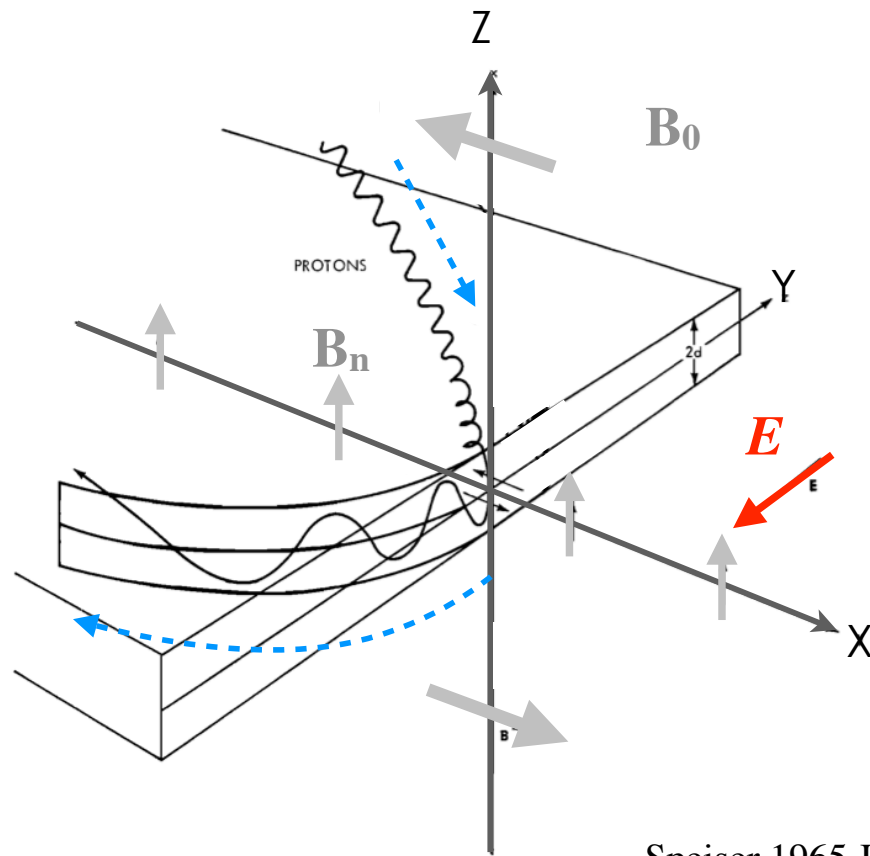

Speiser 1965 JGR

Speiser motion in a moving frame

- Consider a moving frame, in which E is transformed away
- In the velocity space, particle goes through a half ring during the meandering phase.

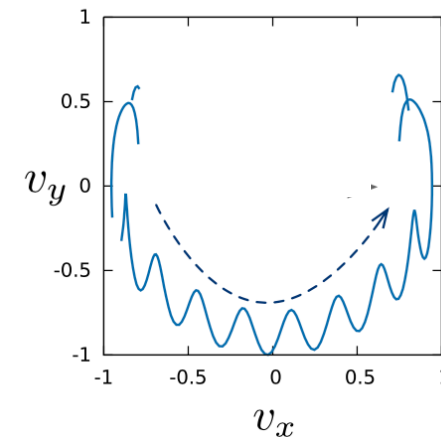
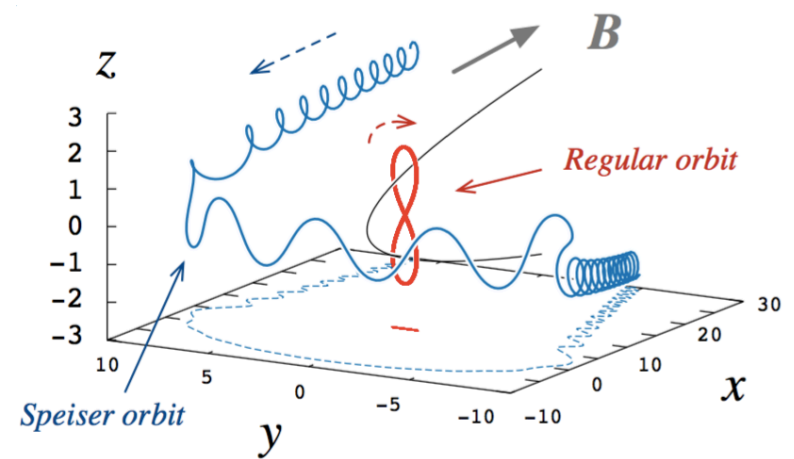
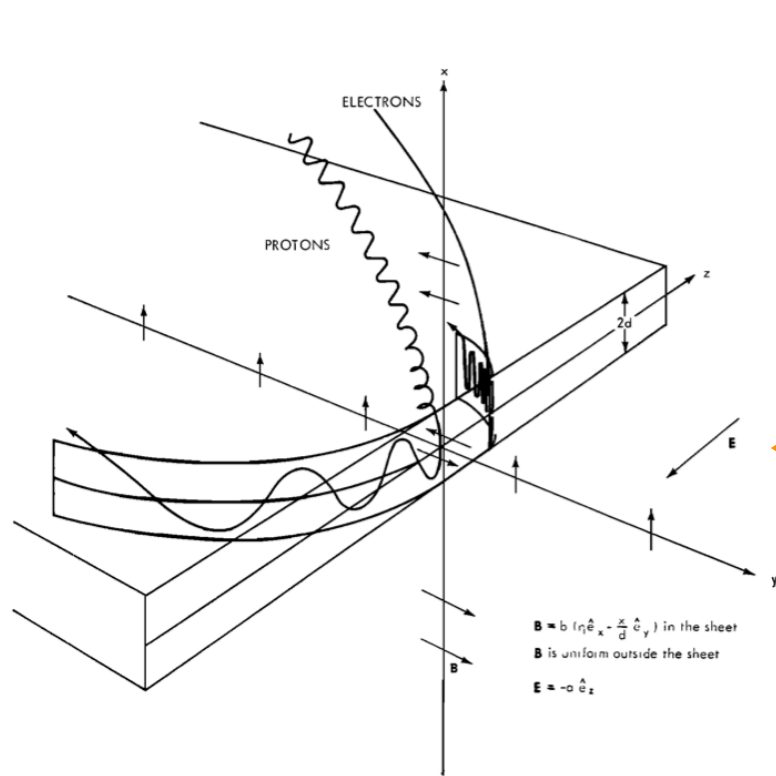

Particle motion in a parabolic field

- Model field

$$\mathbf{B} = B_0(z/L)\mathbf{e}_x + B_n\mathbf{e}_z, \quad \mathbf{E} = 0,$$

- Equation of motion

$$m_e(d\mathbf{v}_e/dt) = -e(\mathbf{v}_e \times \mathbf{B})$$

- can be simplified into:

$$\begin{cases} \ddot{x} = -\Omega_n \dot{y} \\ \ddot{y} = -\omega_b^2 (\dot{z}/|v_e|)z + \Omega_n \dot{x} \\ \ddot{z} = \omega_b^2 (\dot{y}/|v_e|)z, \end{cases}$$

where

$$\Omega_n = eB_n/m_e$$

$$\omega_b = \sqrt{eB_0|v_e|/m_eL}$$

Turning frequency by $B_z (B_n)$

Meandering frequency

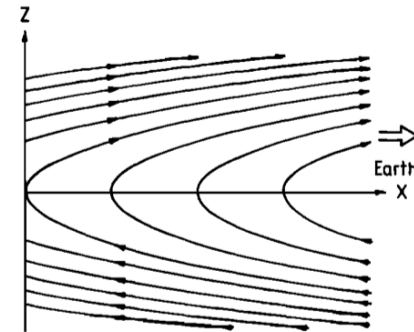

Buchner & Zelenyi
1989 JGR

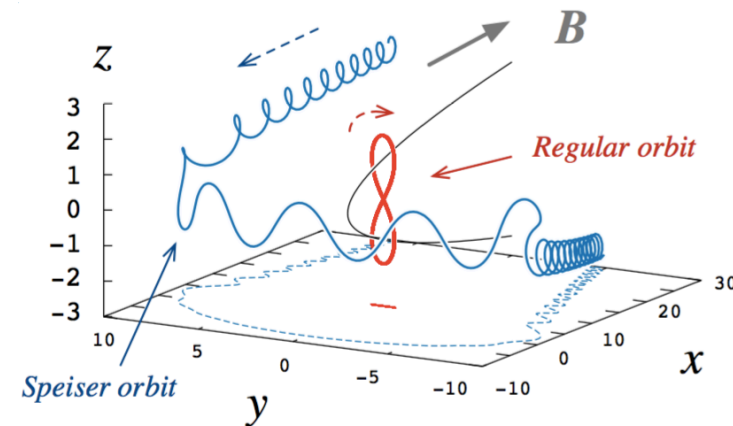

Curvature parameter

- Ratio of the two frequencies
- Ratio of the magnetic curvature radius to the maximum Larmor radius

$$\kappa \equiv \frac{\Omega_n}{\omega_b} = \sqrt{\frac{R_{c,\min}}{r_{L,\max}}}$$

Buchner & Zelenyi 1989 JGR

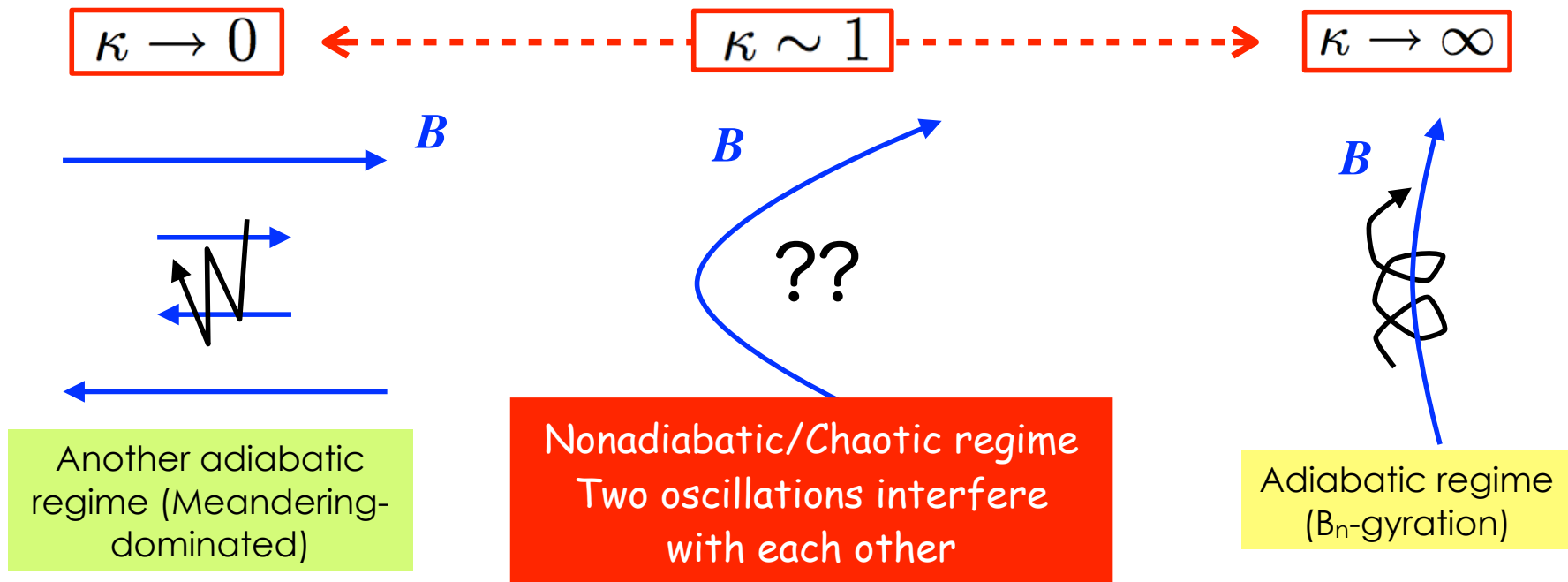

Poincaré map

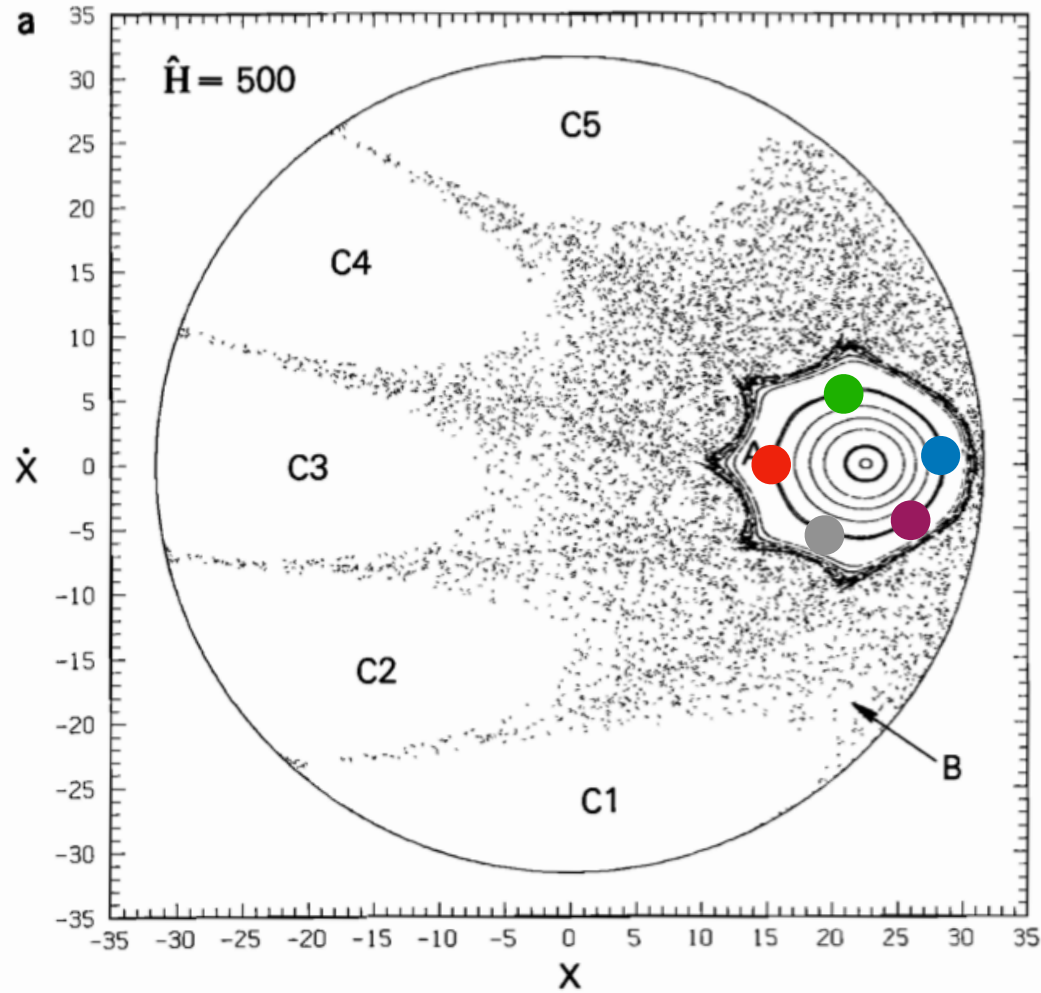

Chen & Palmadesso 1986

- One way to categorize particle orbits

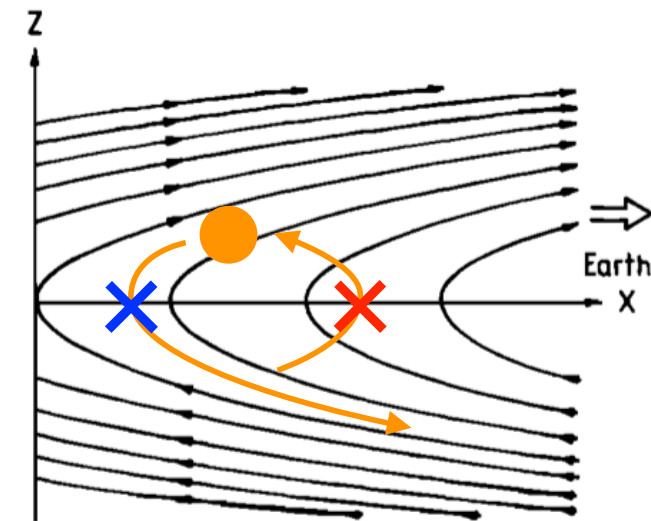

Buchner & Zelenyi 1989

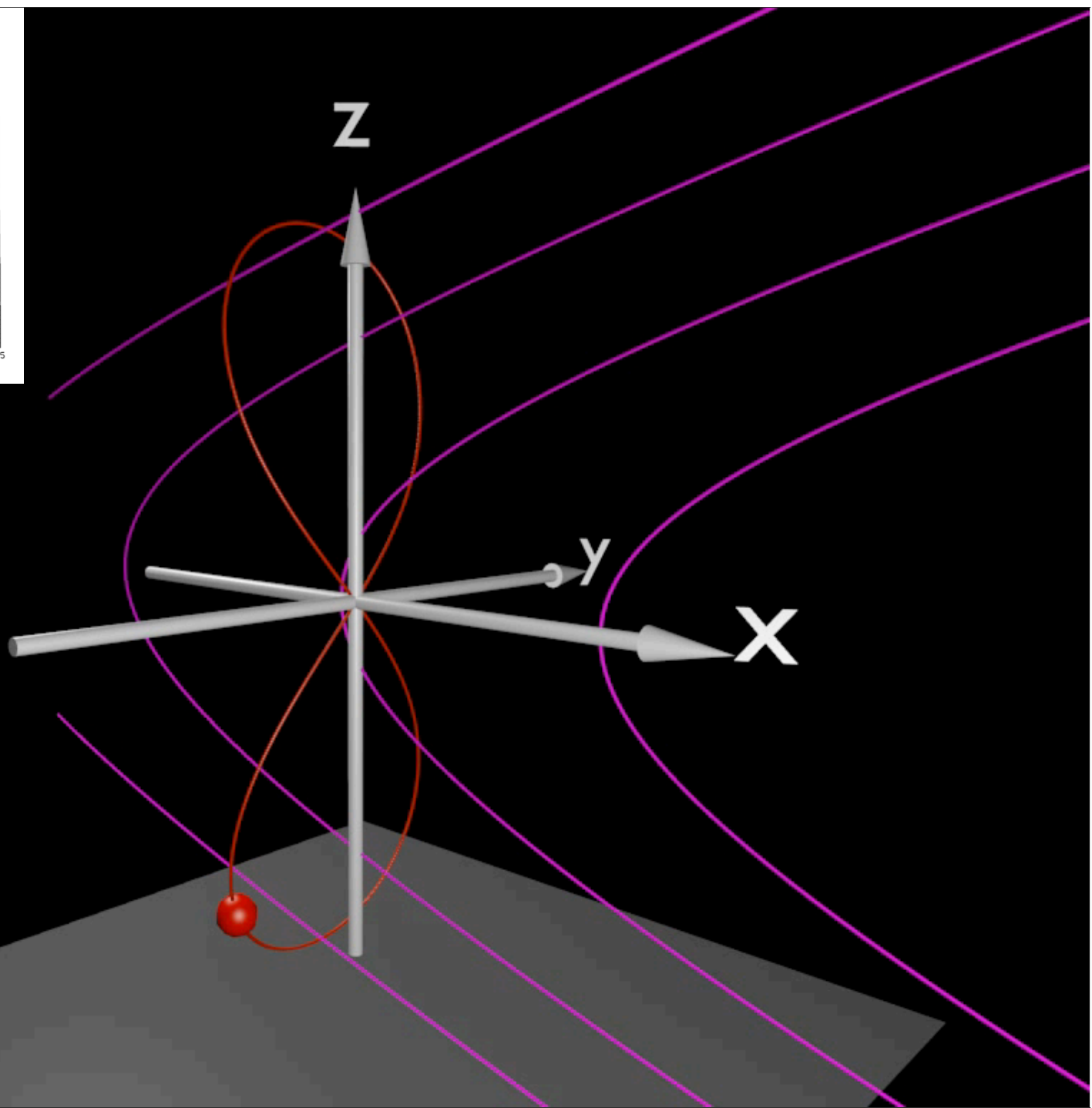
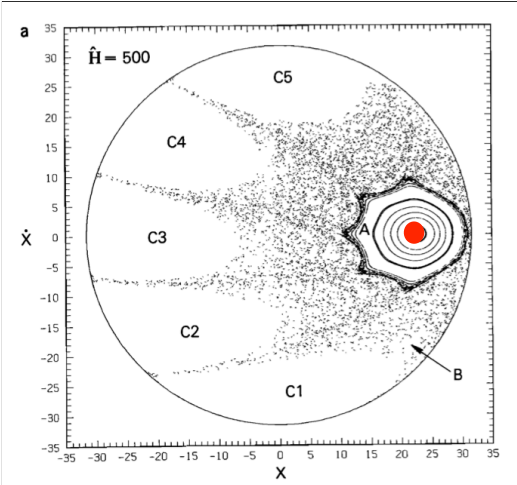

by T. Wada (NAOJ)

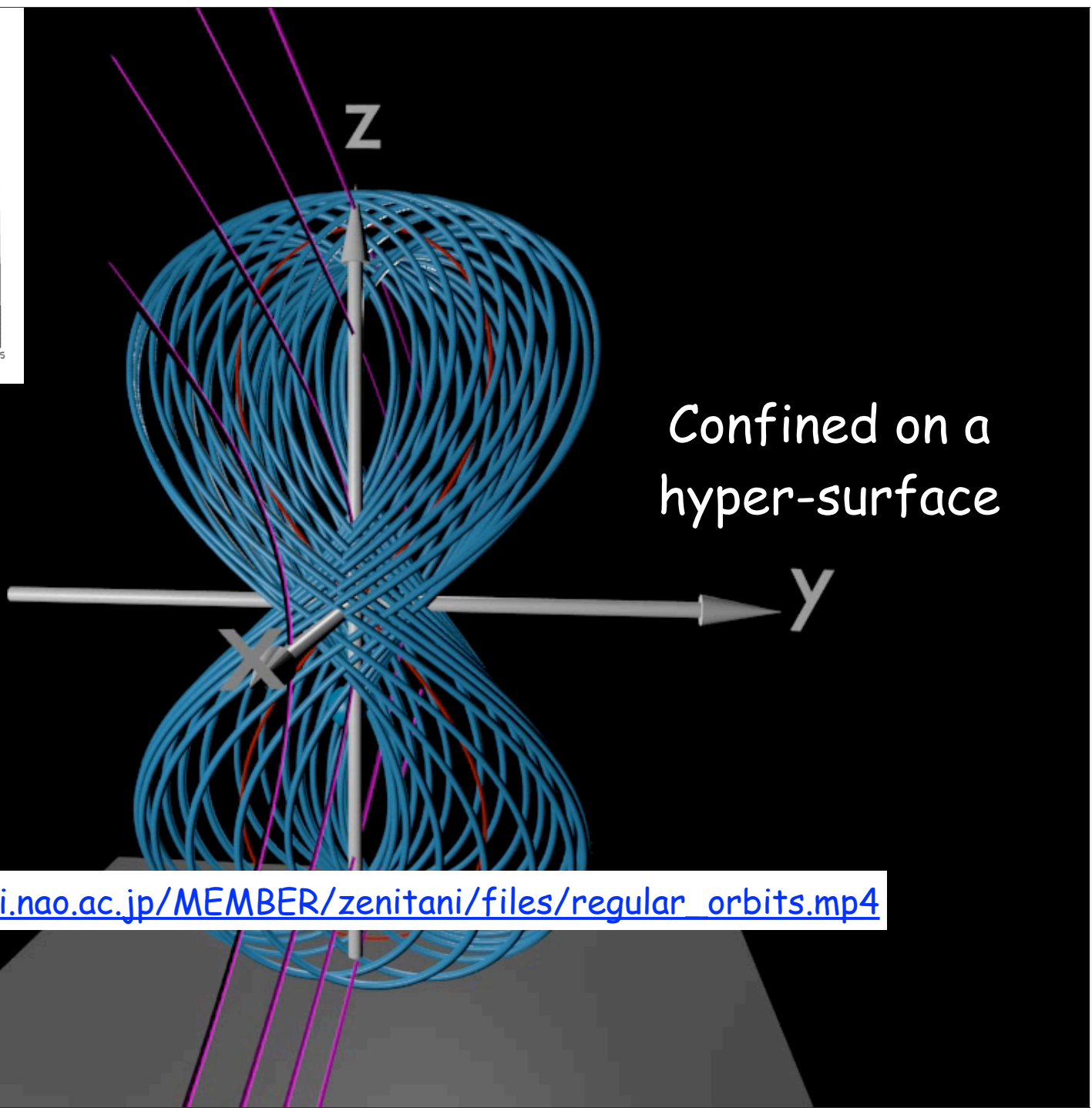
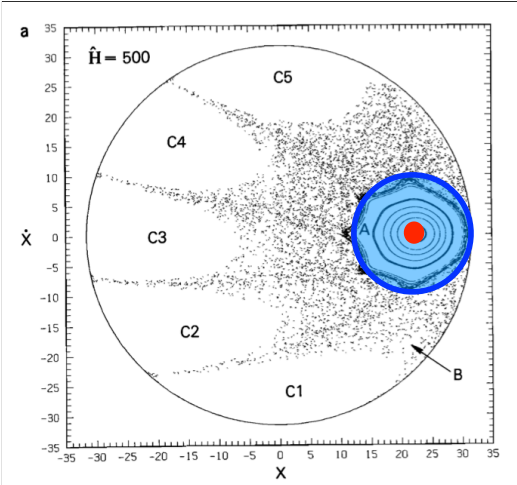

https://sci.nao.ac.jp/MEMBER/zenitani/files/regular_orbits.mp4

by T. Wada (NAOJ)

Speiser motion in Poincaré map

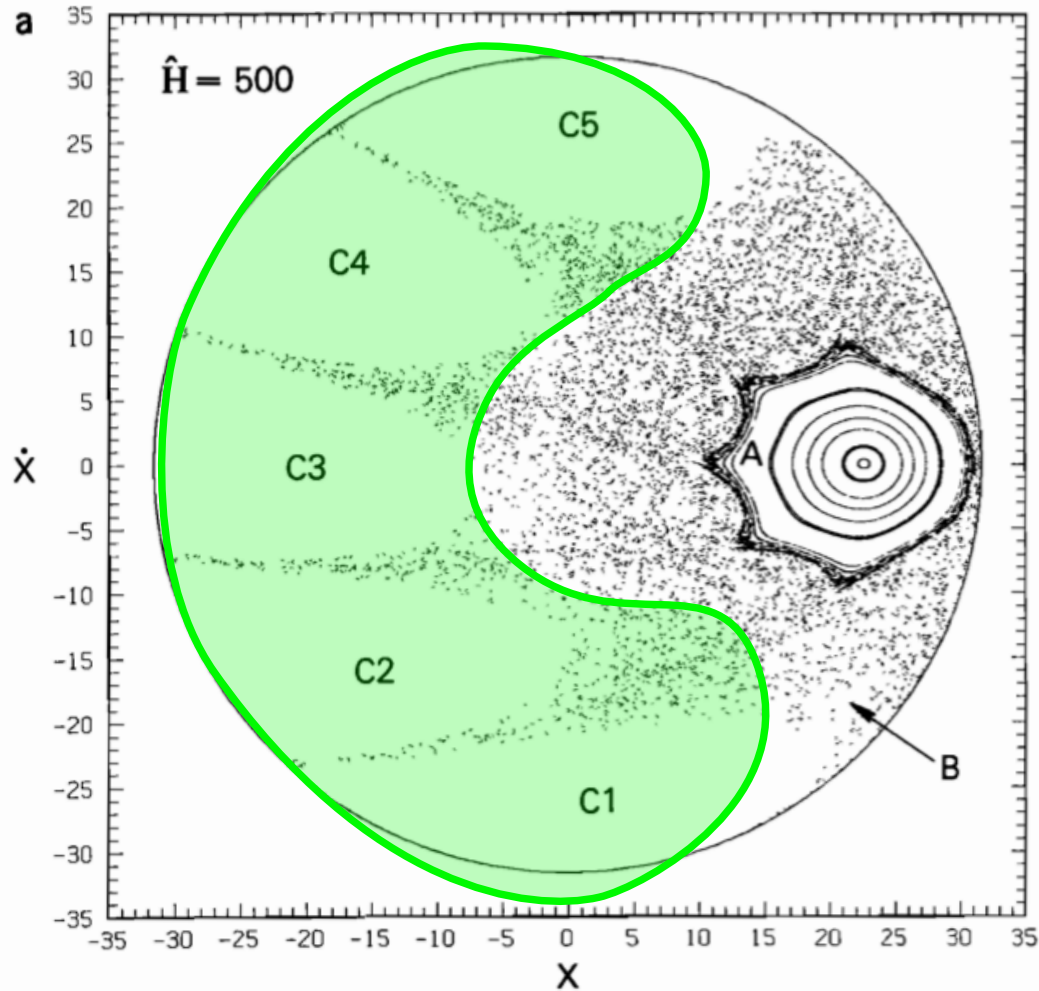

- Empty regions correspond to Speiser motion
- The particle goes far away

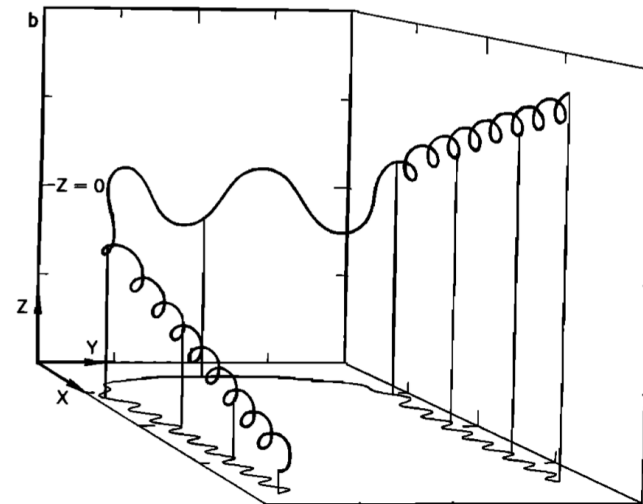

1. Particle motion in a reconnected geometry
2. Ion motion and VDF in the outflow exhaust
3. Electron motion around the reconnection site

2-D PIC simulation

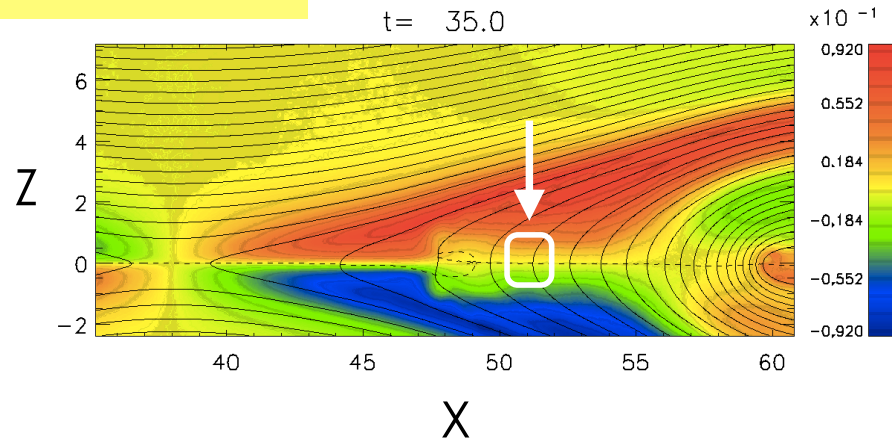

- 2.5D
- $m_i/m_e=100$
- $76.8 \times 38.4 [d_i]$
- Harris sheet
- $n_{bg}/n_{cs} = 0.2$
- 2×10^9 particles

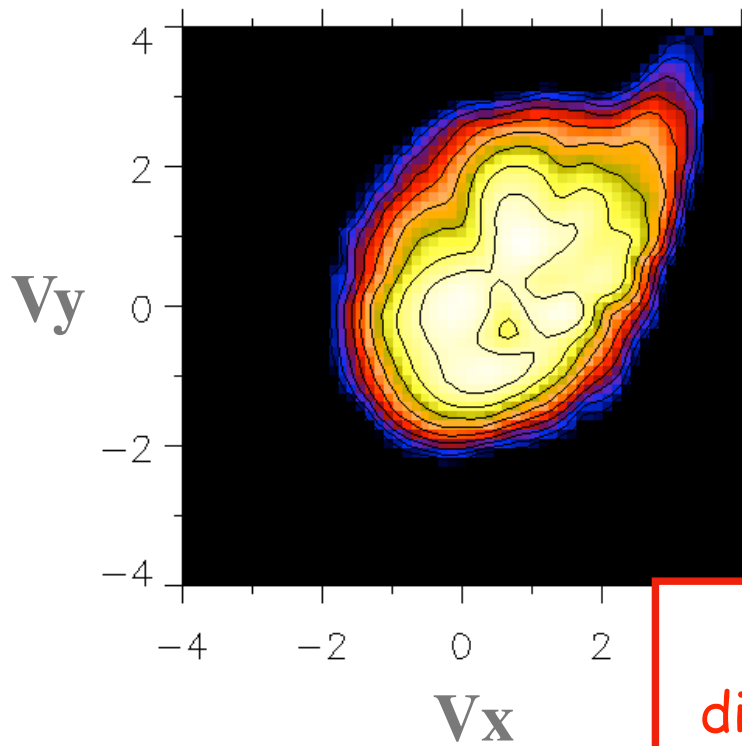

Ion velocity distribution function

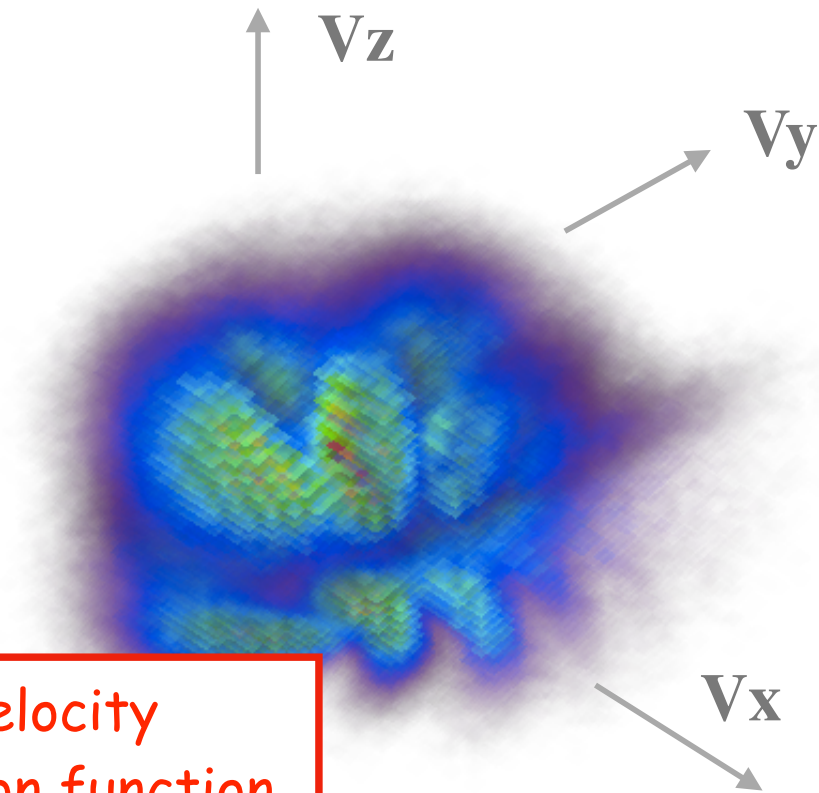

Ion velocity distribution function (VDF)

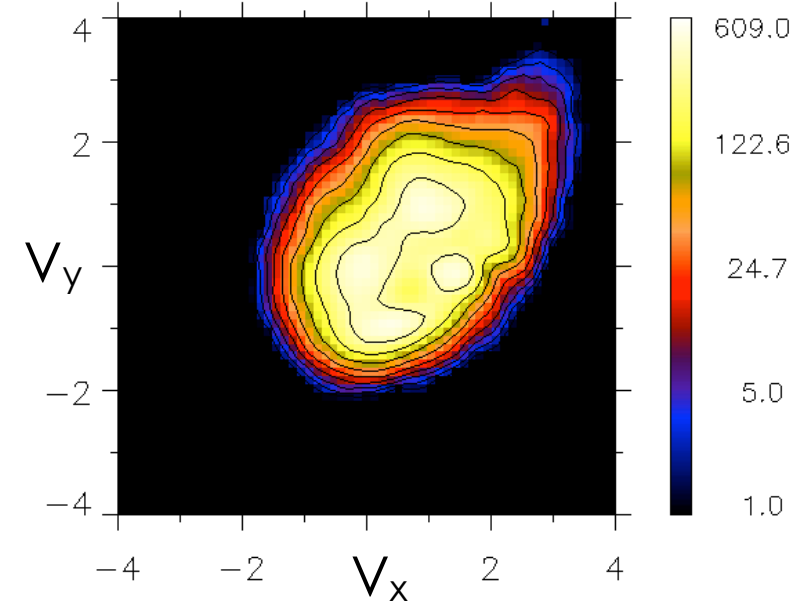
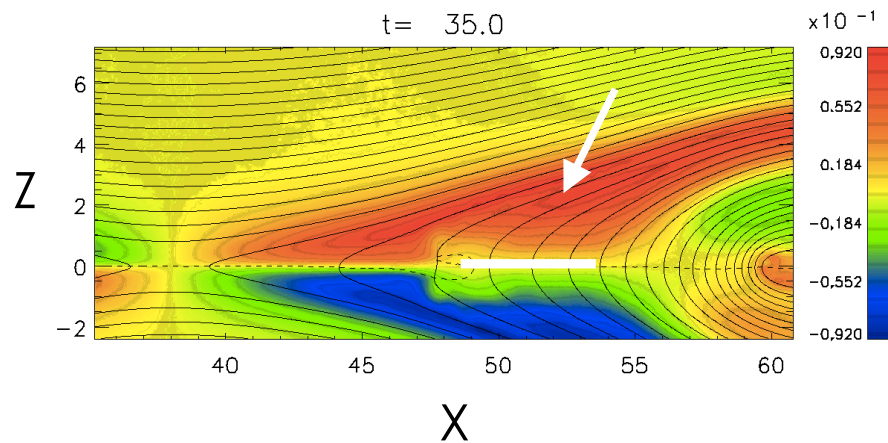
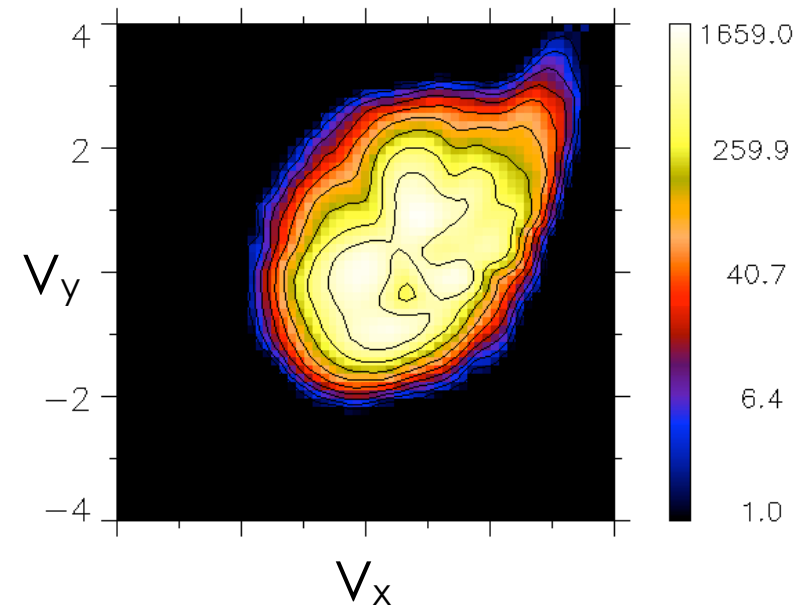
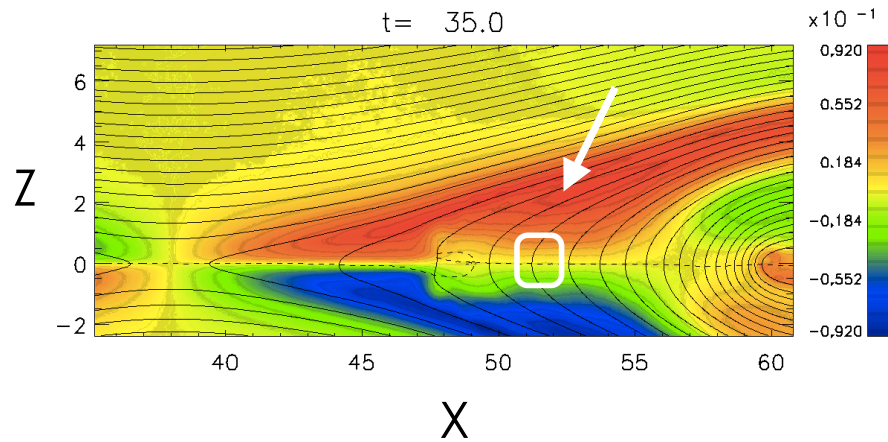

Ion velocity distribution function (VDF)

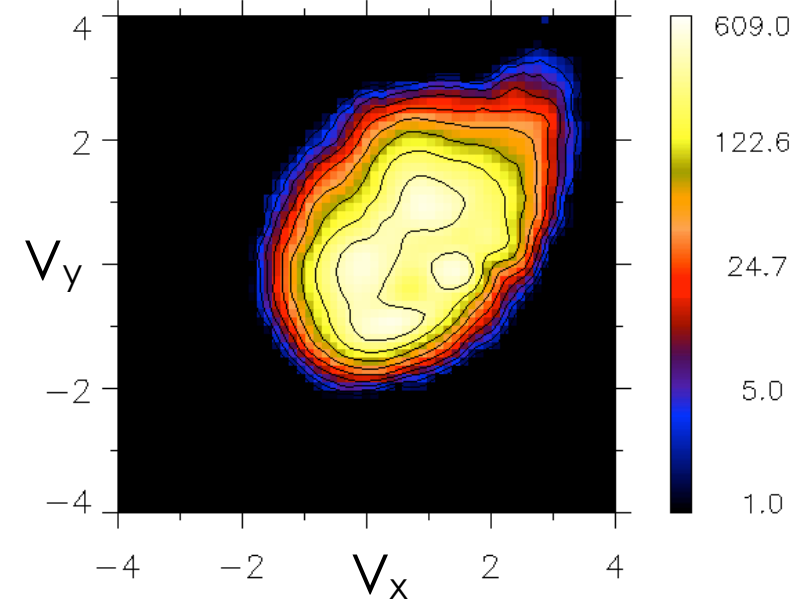
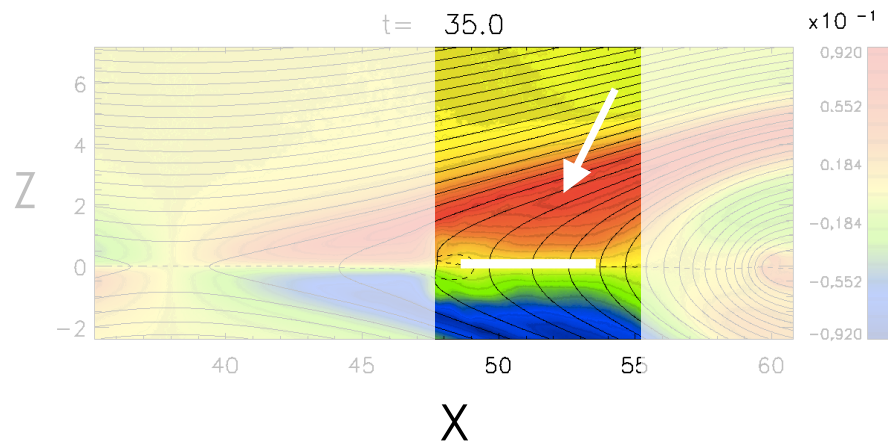
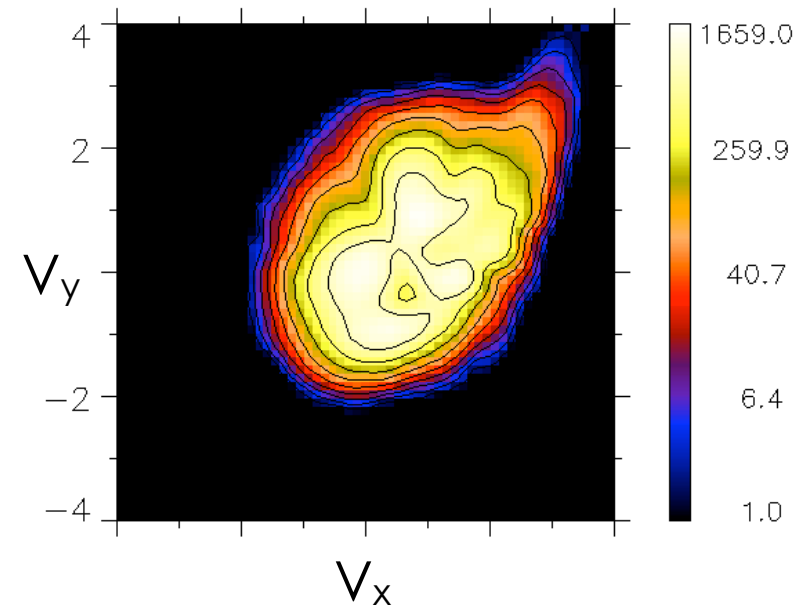
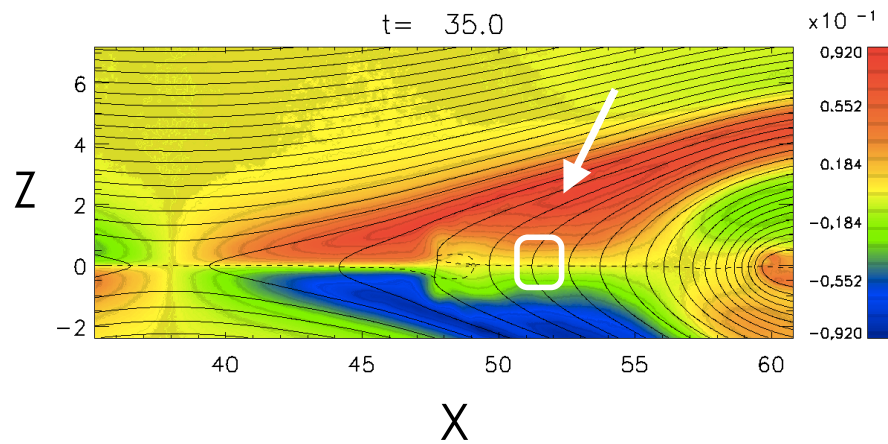

Ion velocity distribution function (VDF)

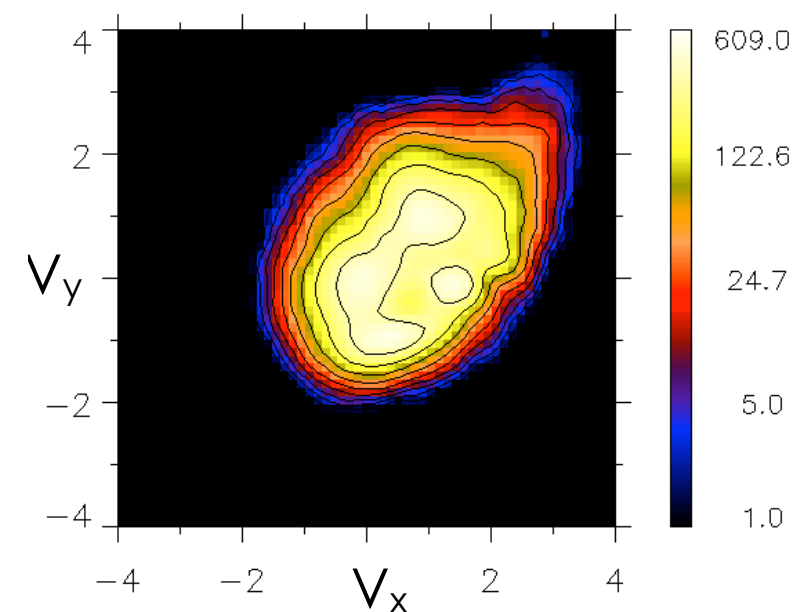
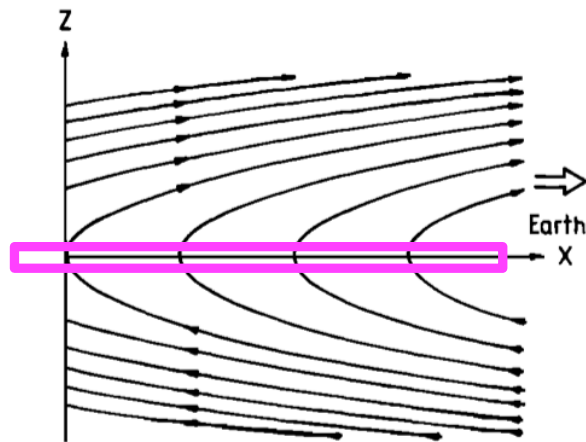
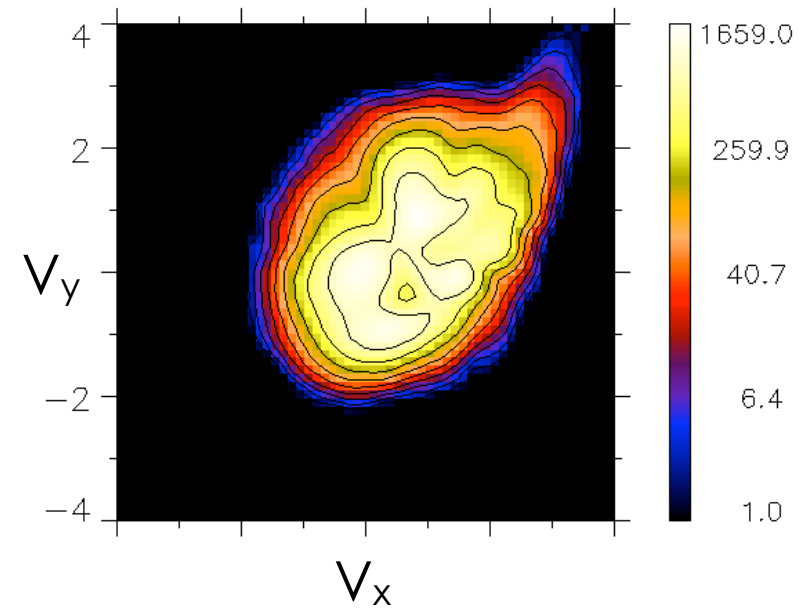
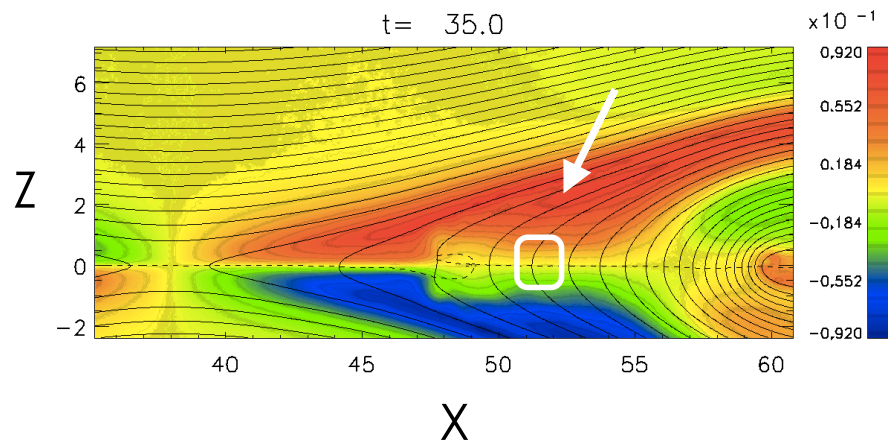

Poincaré map vs 2-D VDF

Mapping of two parameters from 5 (x, y, V_x, V_y, V_z)
Similar systems — two degrees of freedom

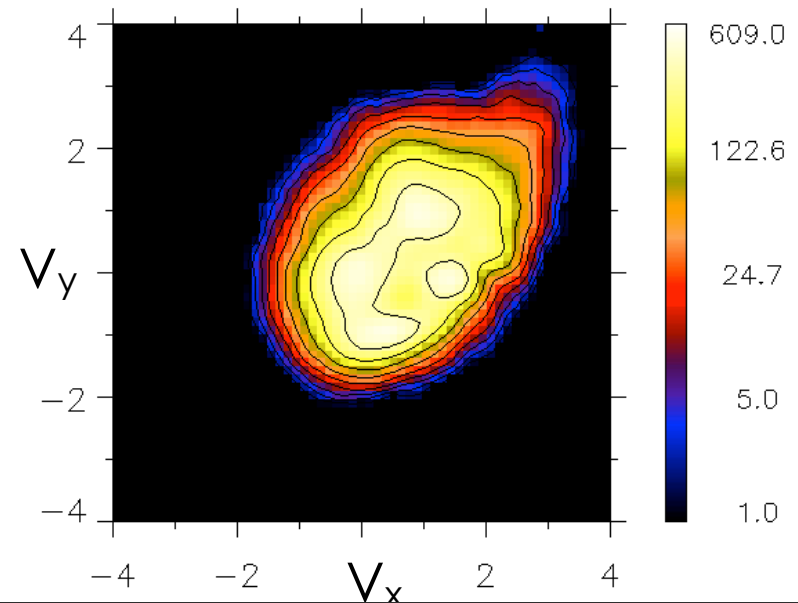
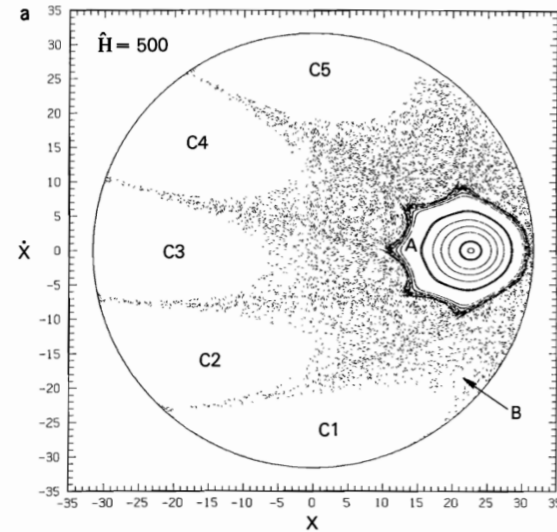
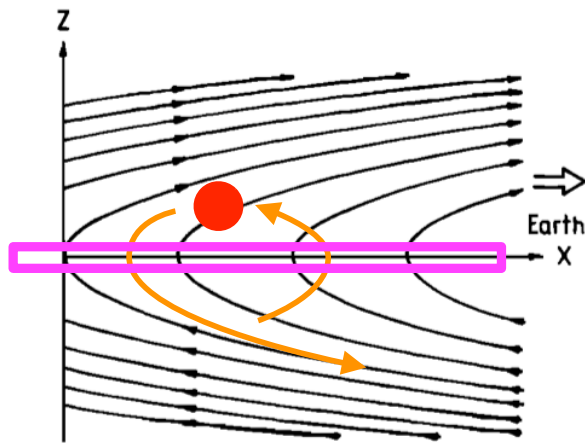
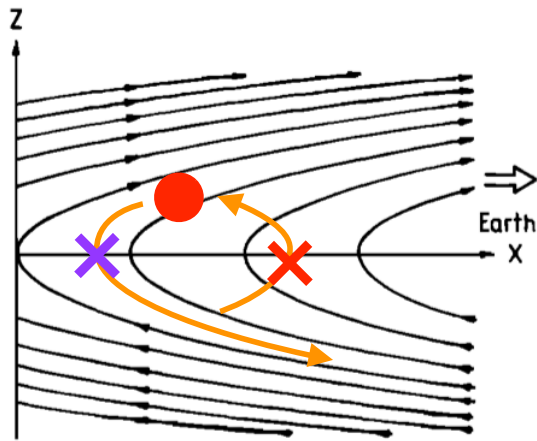

Poincaré map vs 2-D VDF

Mapping of two parameters from 5 (x, y, V_x, V_y, V_z)
Similar systems — two degrees of freedom

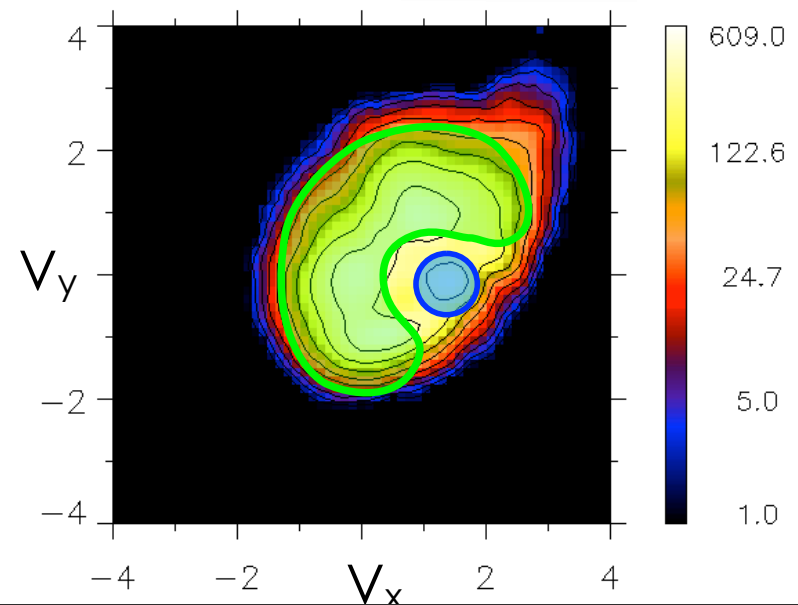
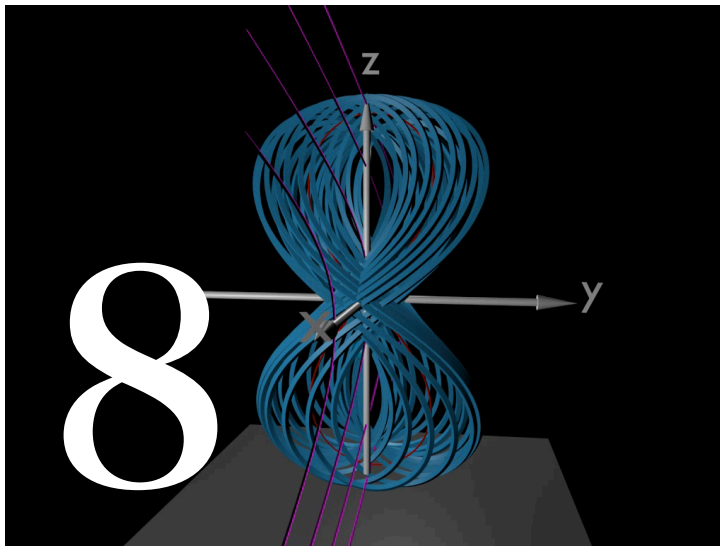
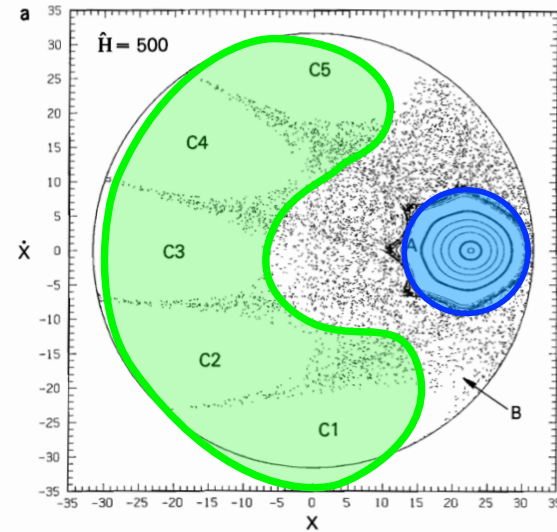
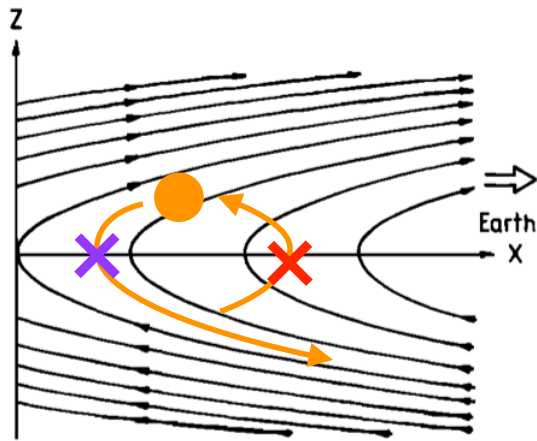

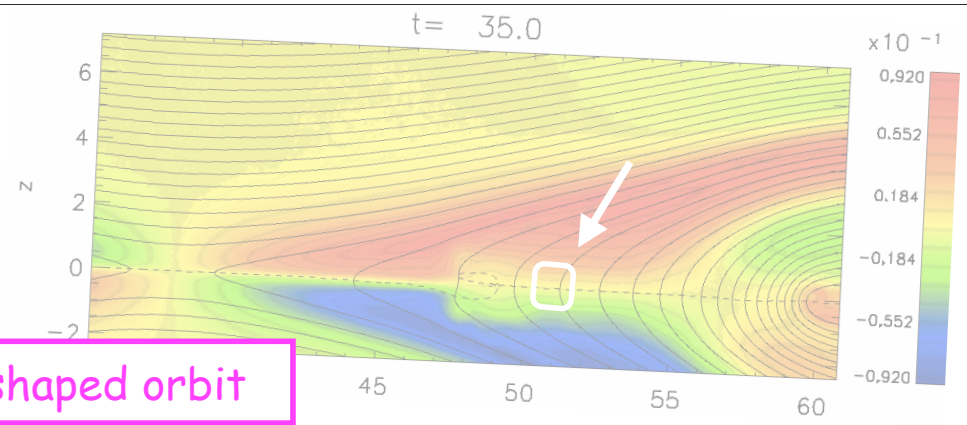

8-shaped orbit

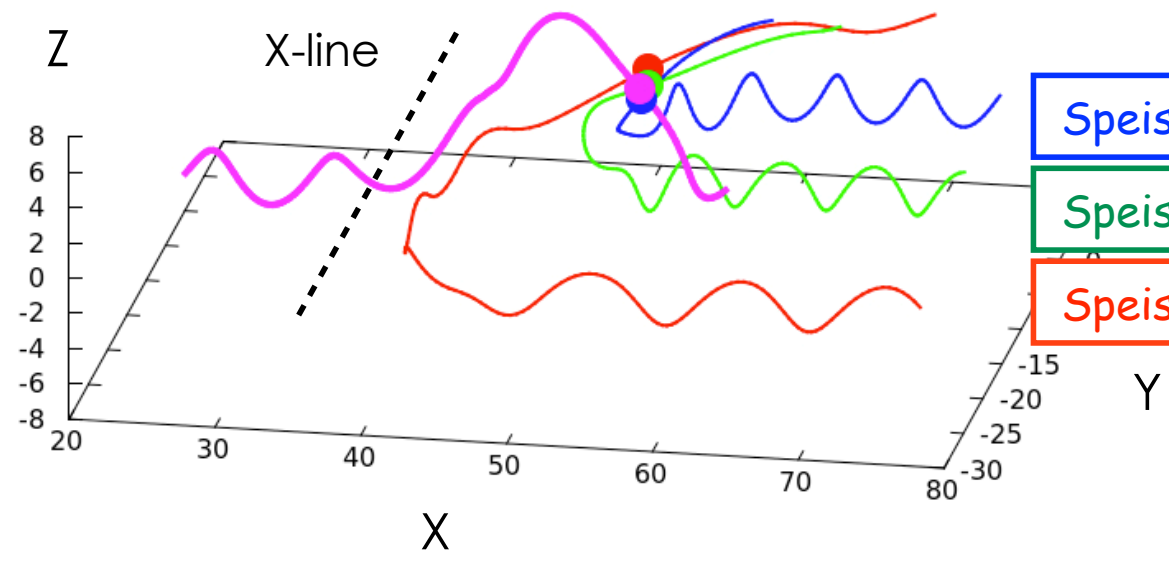

Speiser orbit (known)

Speiser orbit (known)

Speiser orbit (known)

Ion orbits in PIC simulation

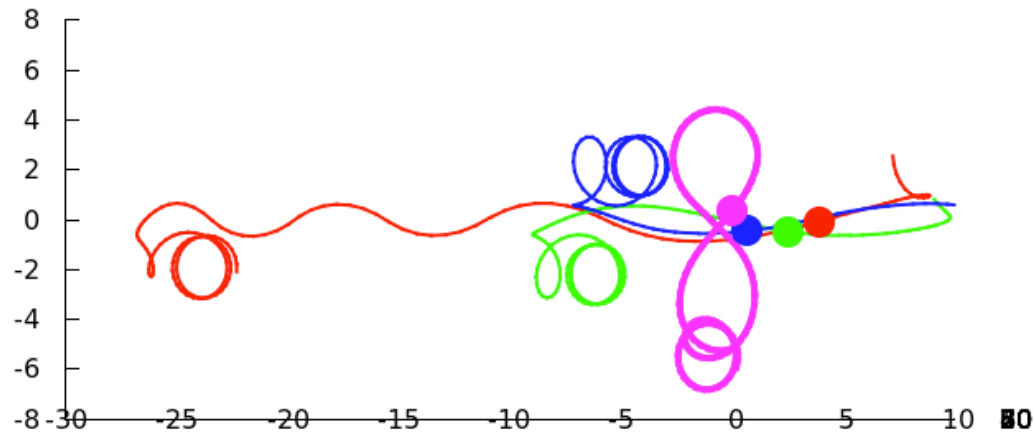

8-shaped orbit in a rotated,
moving (outflow) frame

We have discovered figure-8-shaped ion orbits in reconnection

Signatures of 8-shaped-orbit ions

- Occasionally found in the near-exhaust

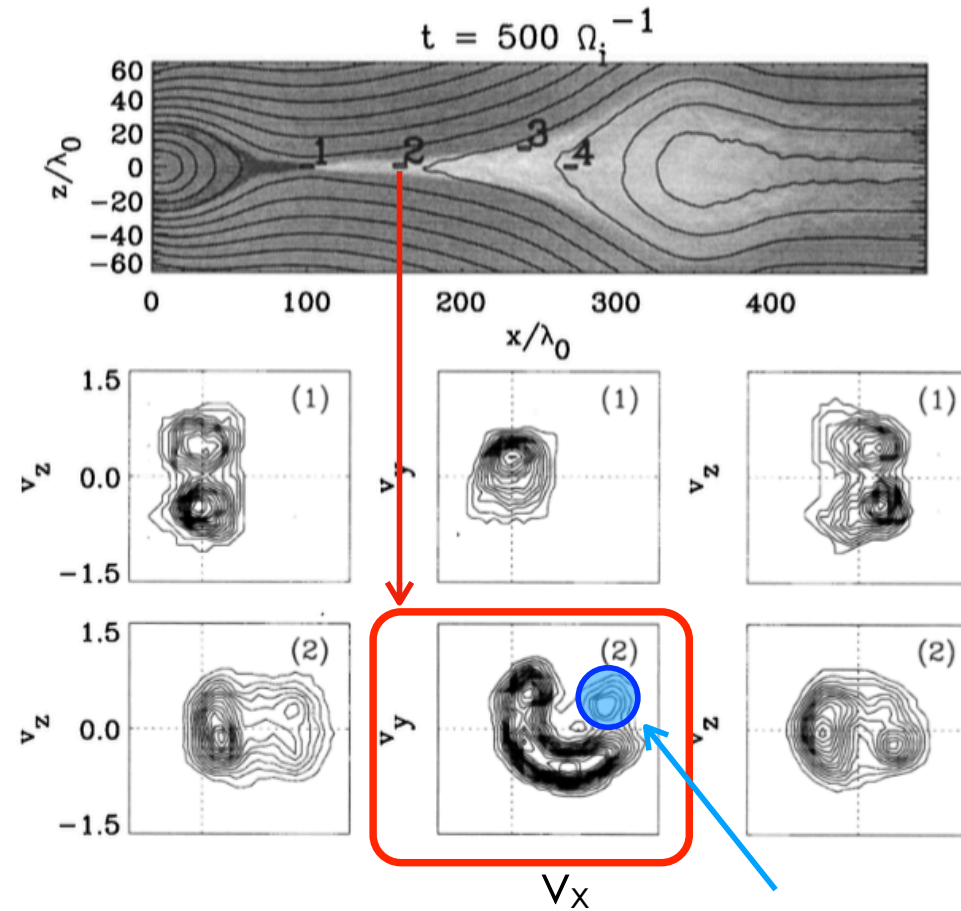
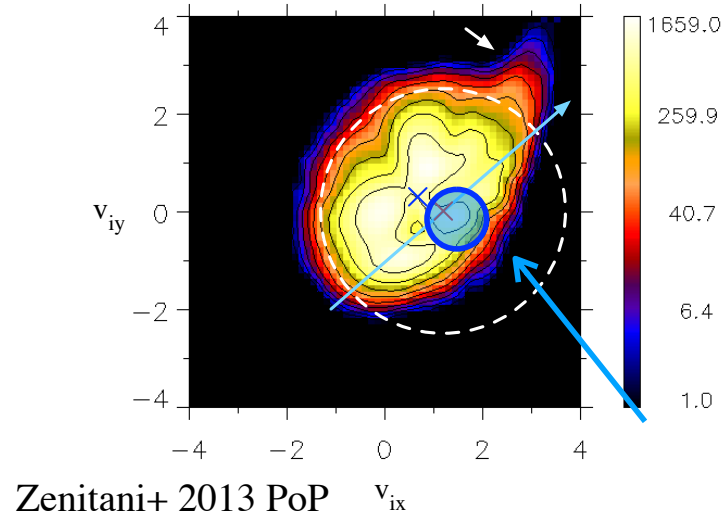

Arzner & Scholer 2001 JGR

Signatures of Speiser motion

- A half ring corresponds to Speiser motion in the outflow frame

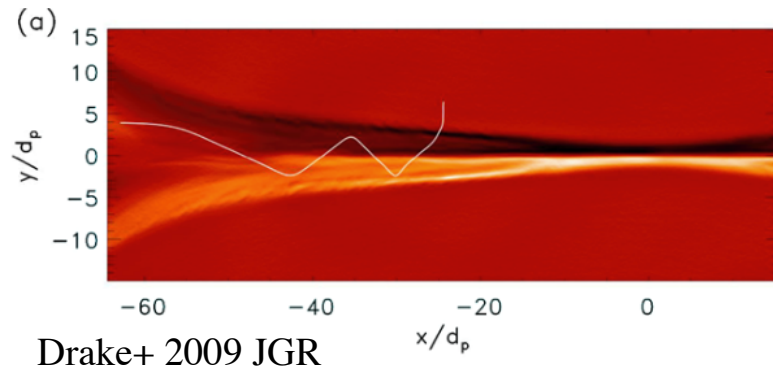

PIC simulations

Hybrid simulation

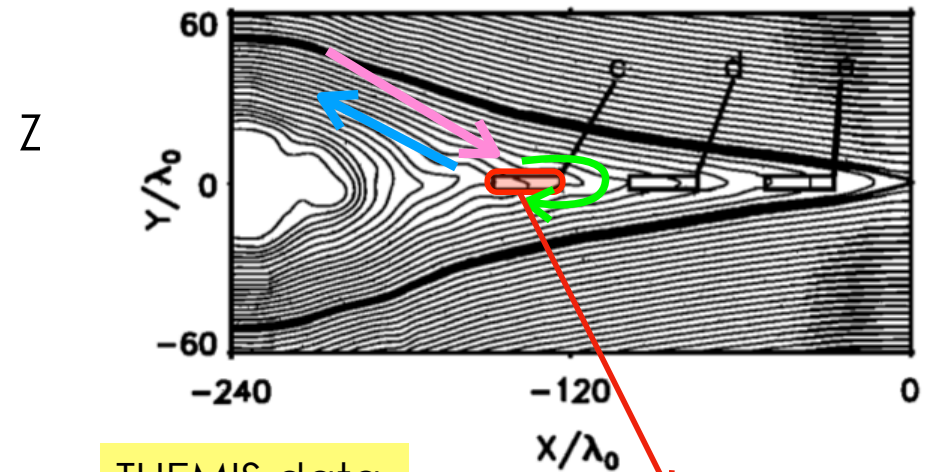

THEMIS data

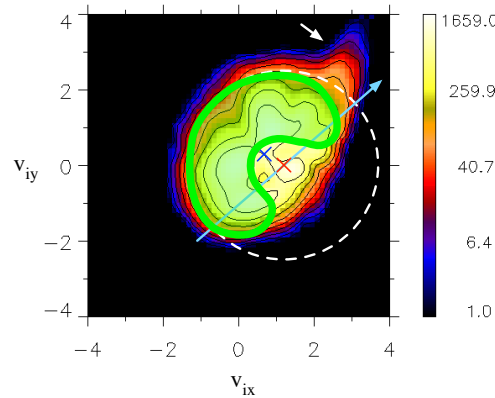

Zenitani+ 2013 PoP

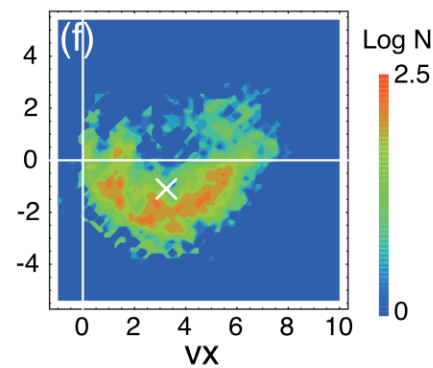

Fujimoto+ 2016 PoP

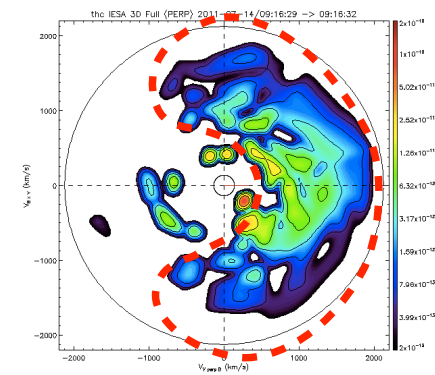

Hietala+ 2015 GRL

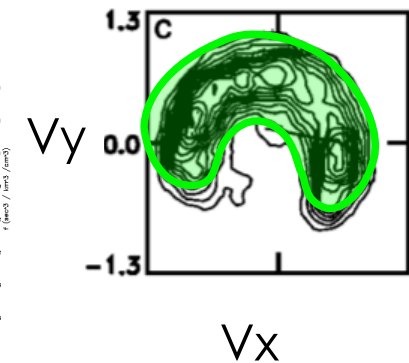

Lottermoser+ 1998 JGR

1. Particle motion in a reconnected geometry
2. Ion motion and VDF in the outflow exhaust
3. Electron motion around the reconnection site

Electron orbits in PIC simulation

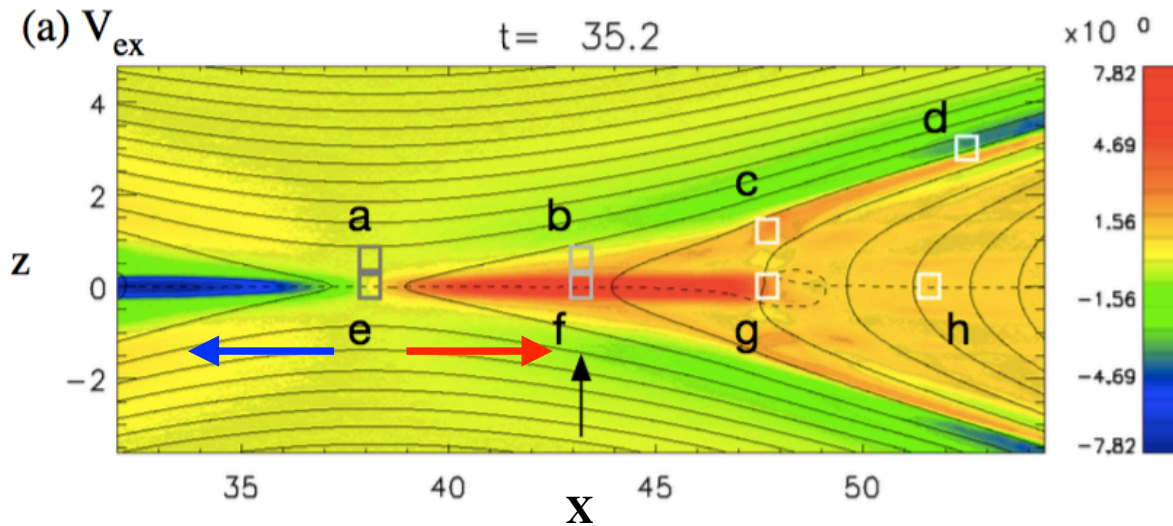

- 2.5D
- $m_i/m_e = 100$
- 76.8×38.4 [d_i]
- Harris sheet
- $n_{bg}/n_{cs} = 0.2$
- 2×10^9 particles

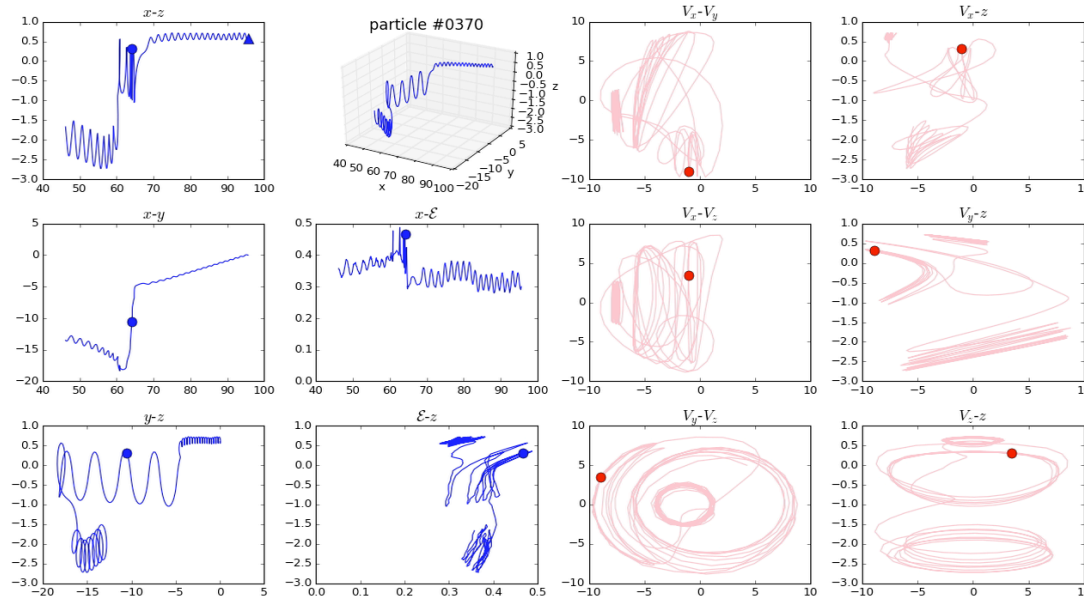

- **20,000,000 electron orbits from 1250 snapshot data**
- 3,000 orbits are inspected with human eyes

Electron Speiser orbits

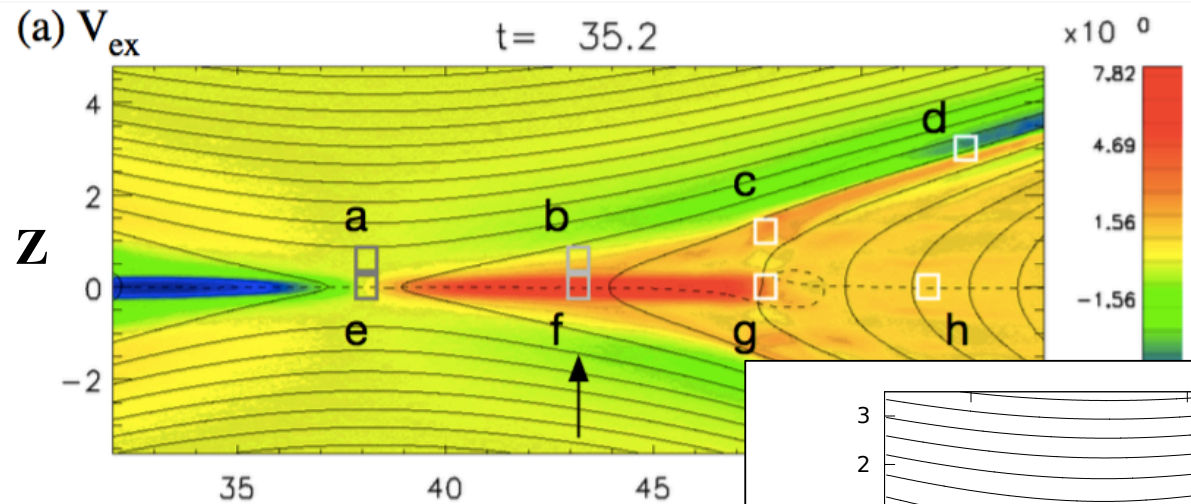

Speiser orbit
via X-line region
Another Speiser orbit
of reflection type

Front view

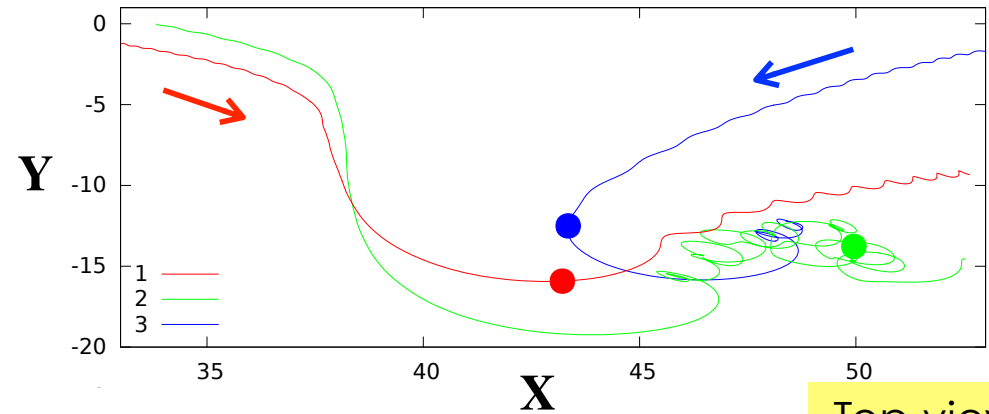
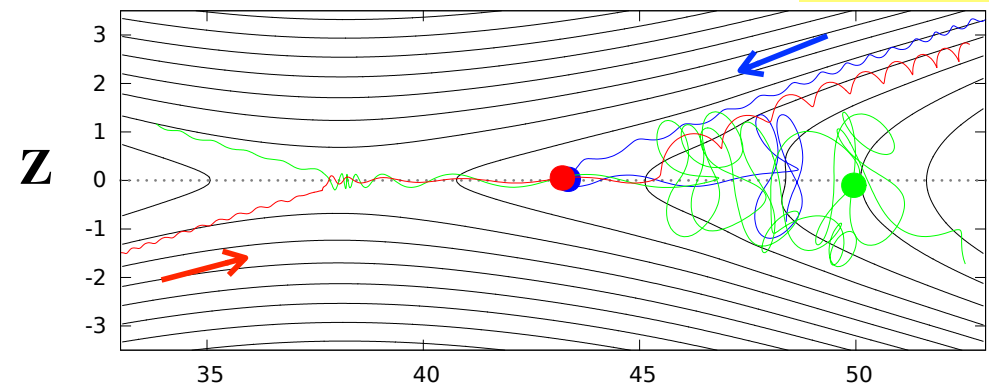
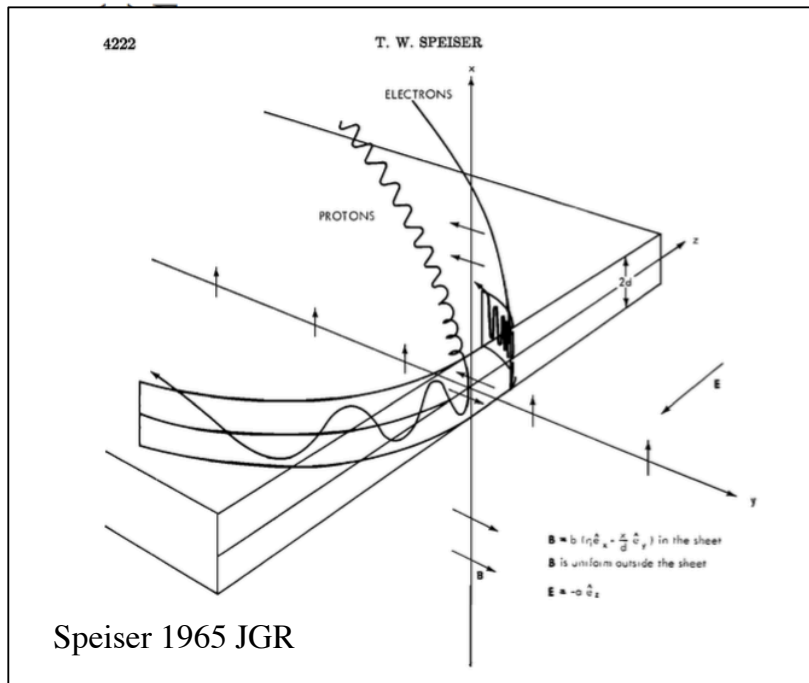

Top view

Electron 8-shaped orbit

(b) V_{ex} $t = 35.2$ $\times 10^0$

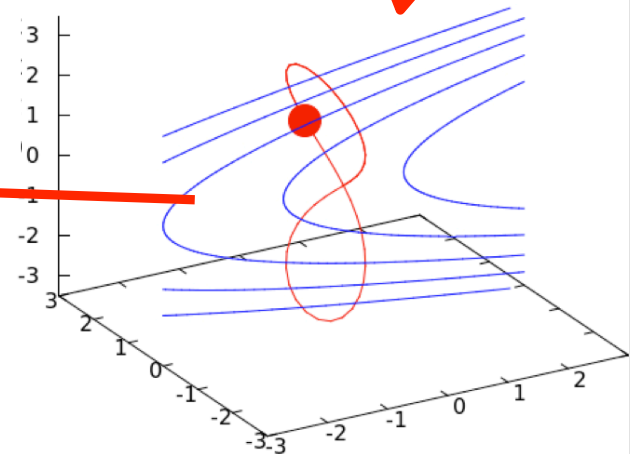
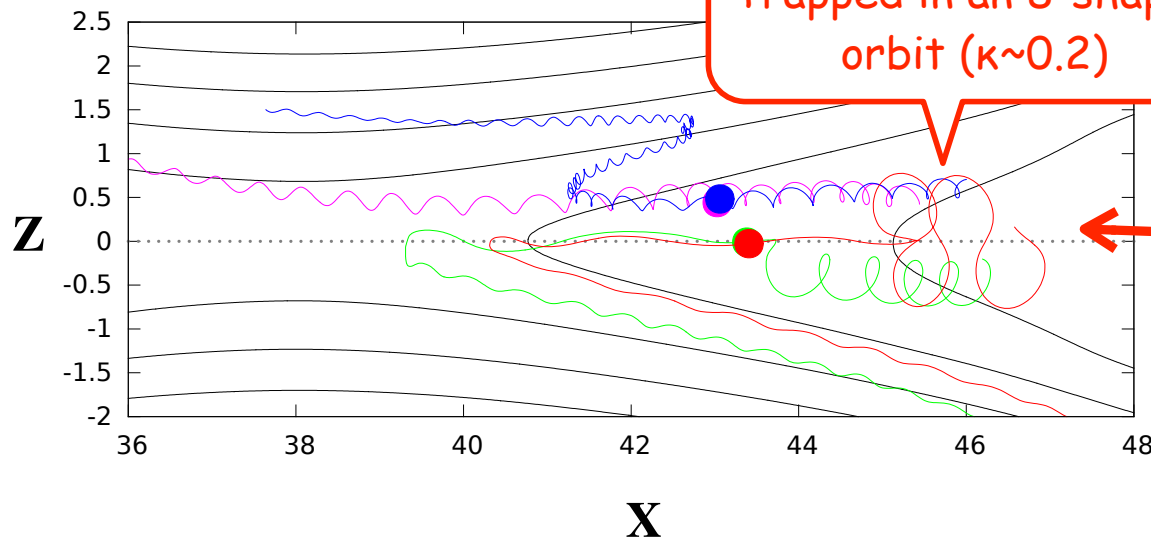
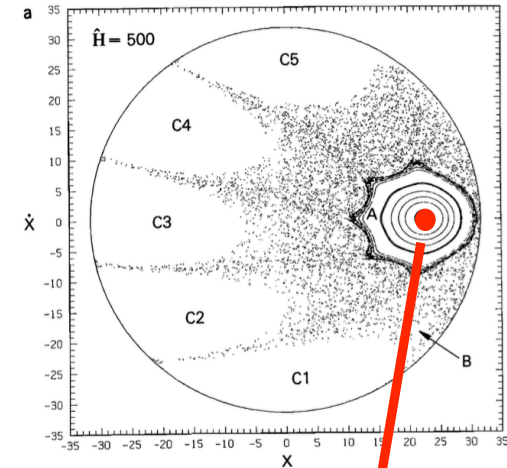
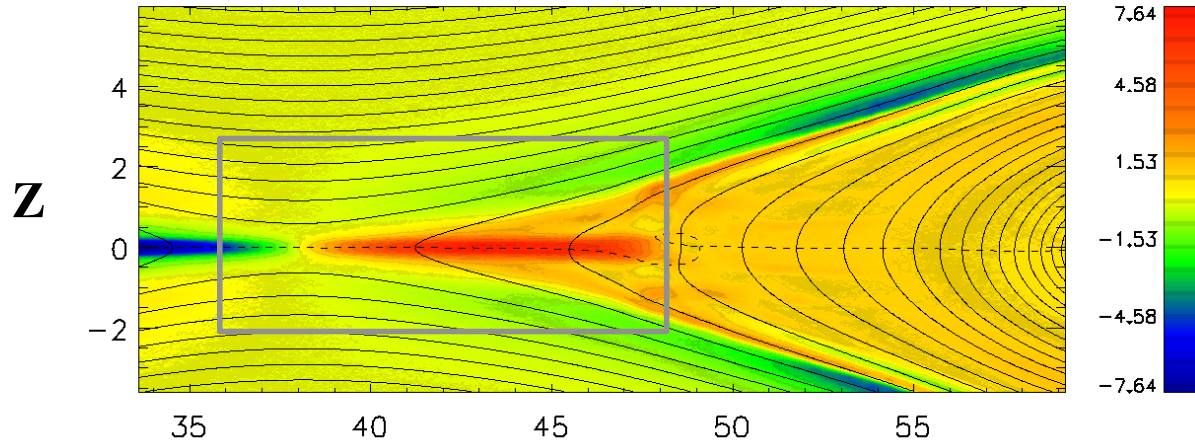

Chen & Palmadesso 1986 JGR

Surprise: Noncrossing electrons

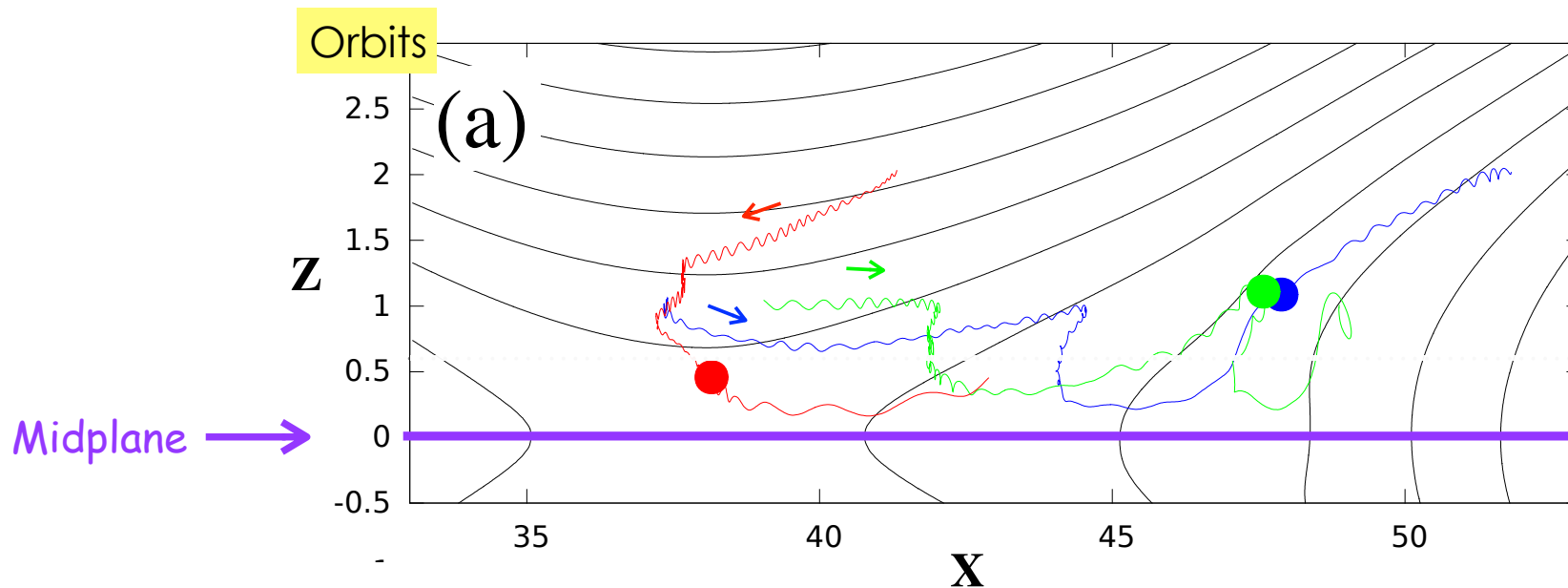

Traditional Speiser orbits

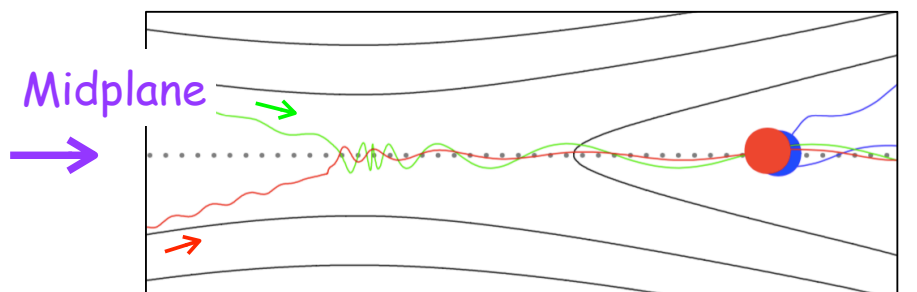

Electrostatic field E_z

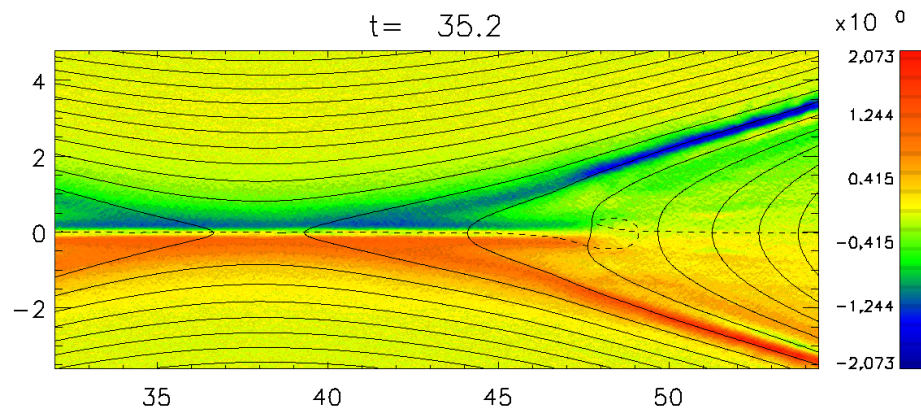

Surprise: Noncrossing electrons

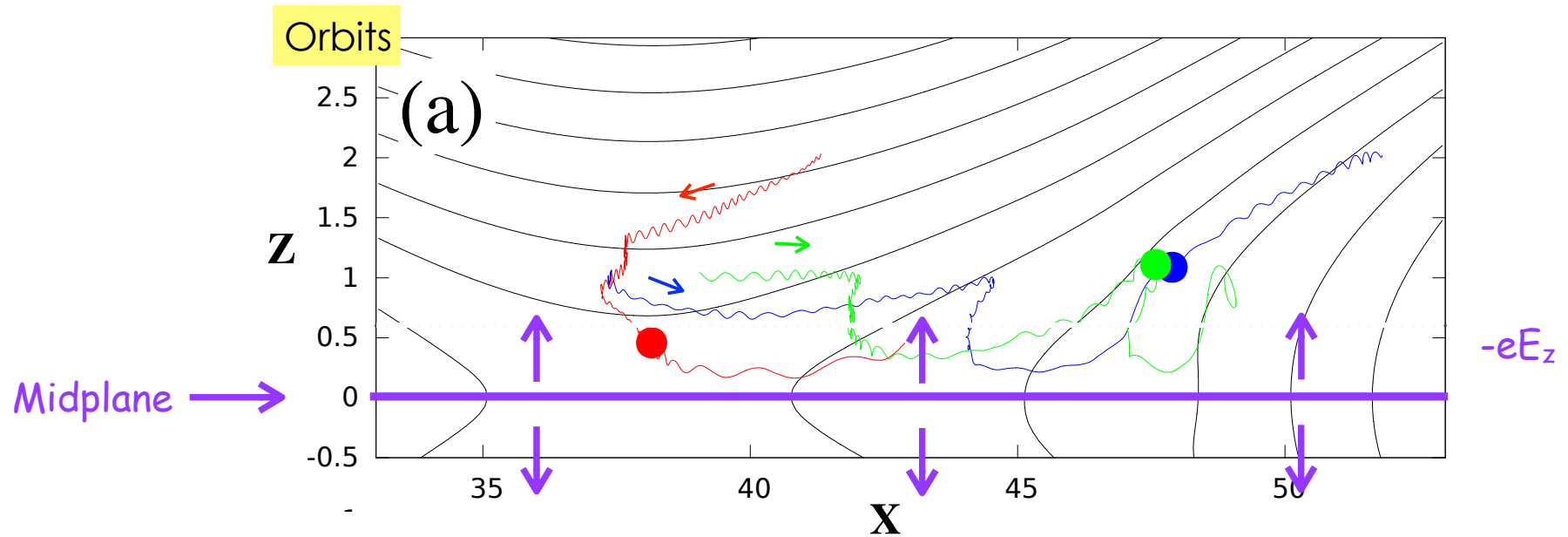

Traditional Speiser orbits

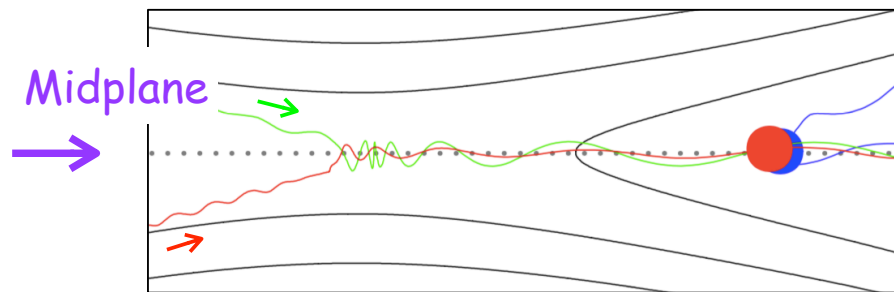

Electrostatic field E_z

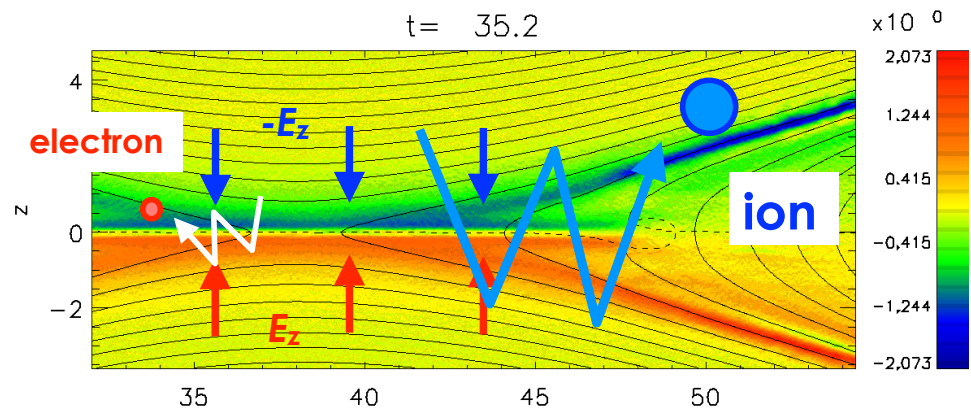

Orbit theories

1965

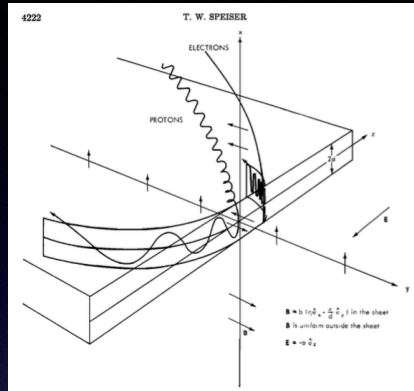

Speiser 1965

1980's

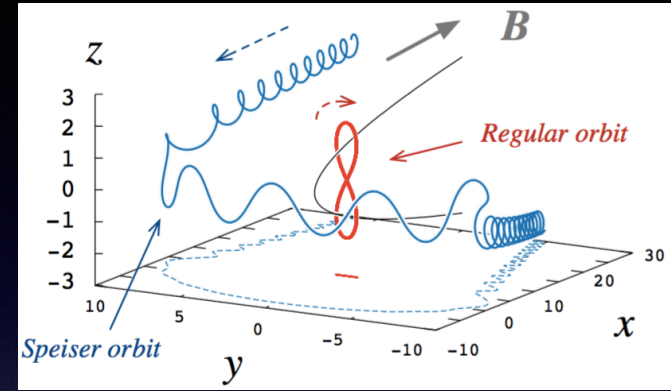

Chen & Palmadesso 1986, Buchner & Zelenyi 1989

2016

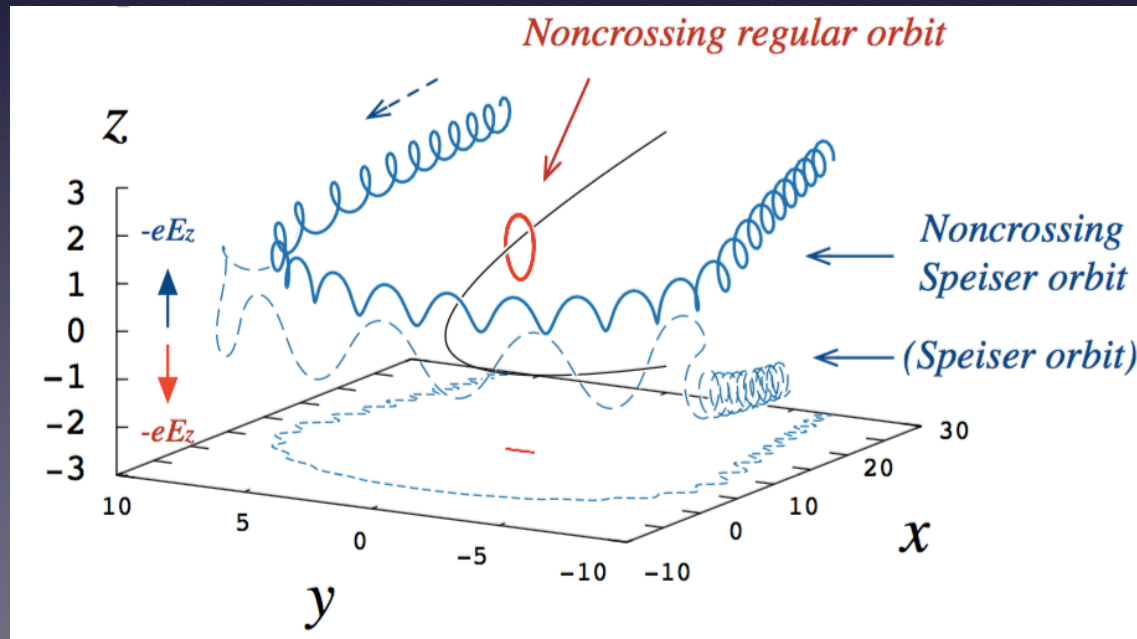

A related theory came out recently:
Tsai+ 2017

Zenitani & Nagai 2016

Previous picture of electron orbits

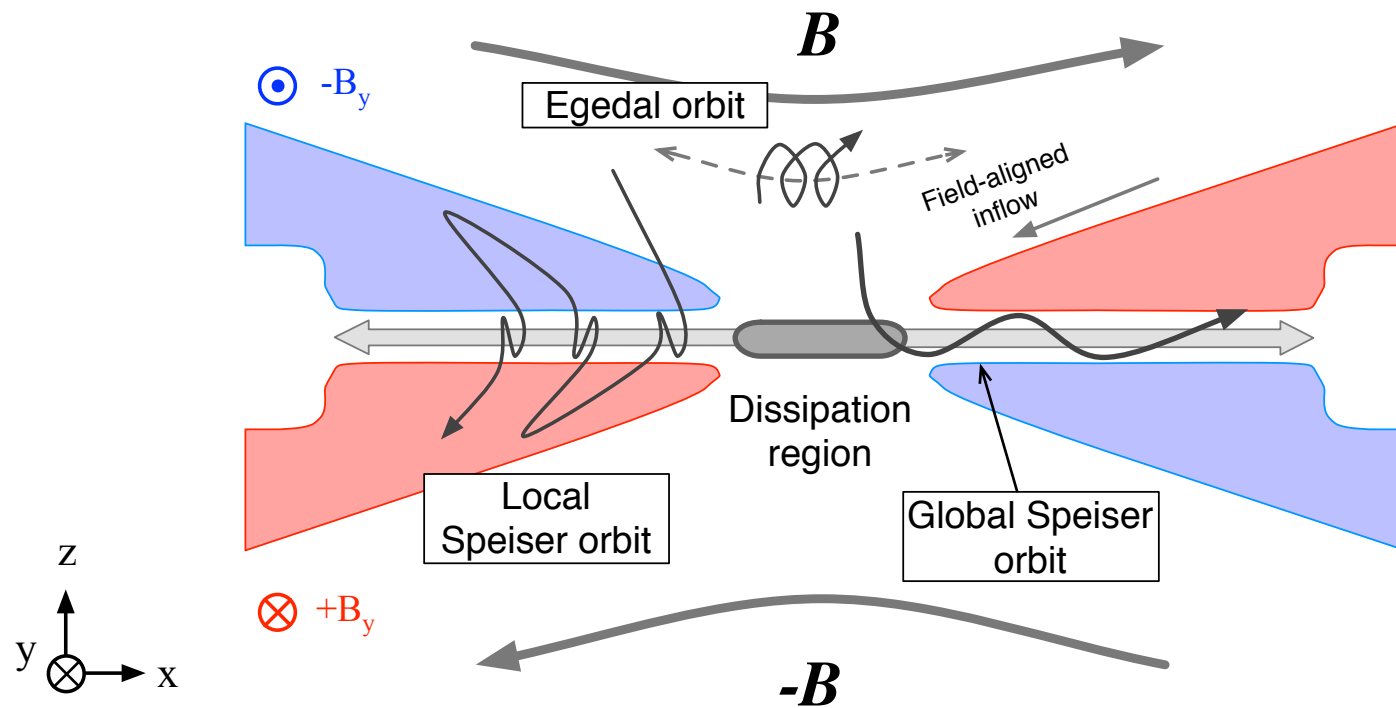

New picture of electron orbits

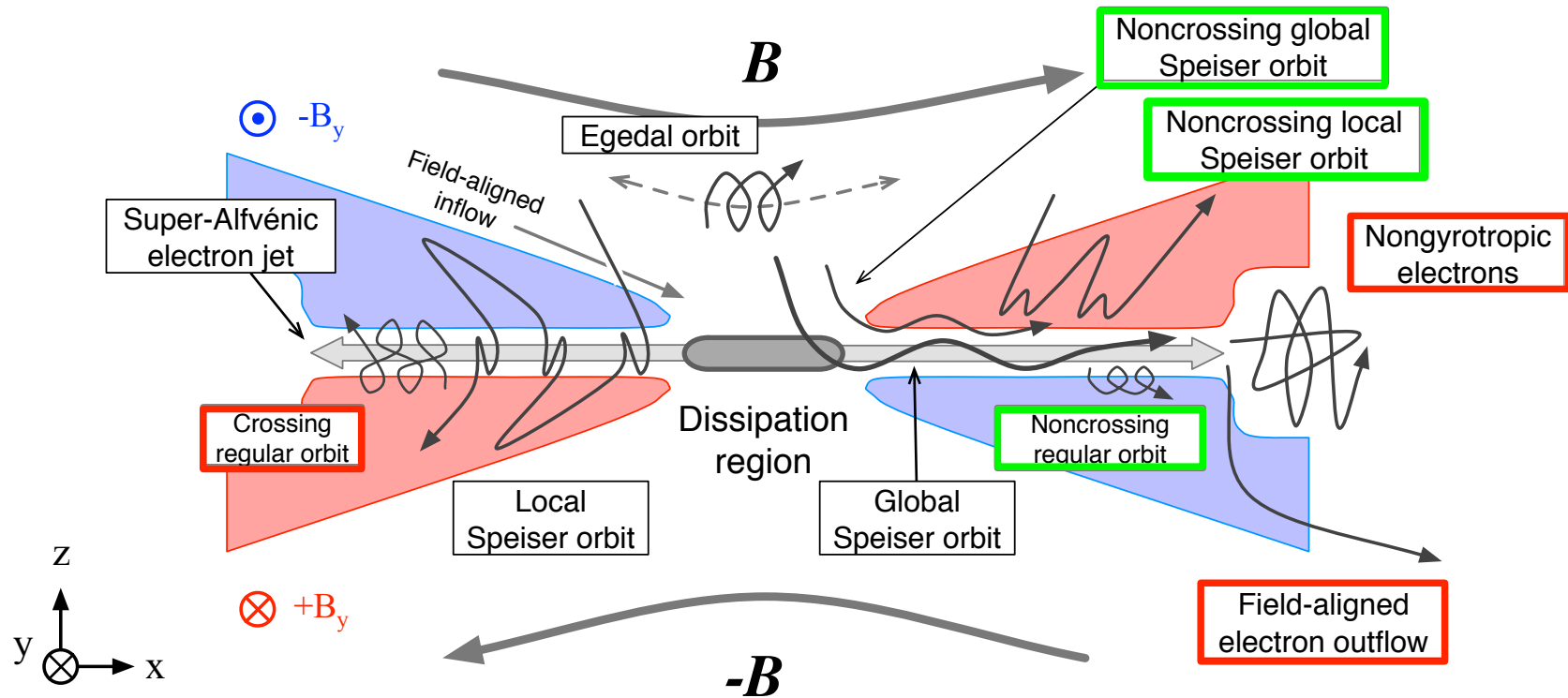

Noncrossing electrons in VDF

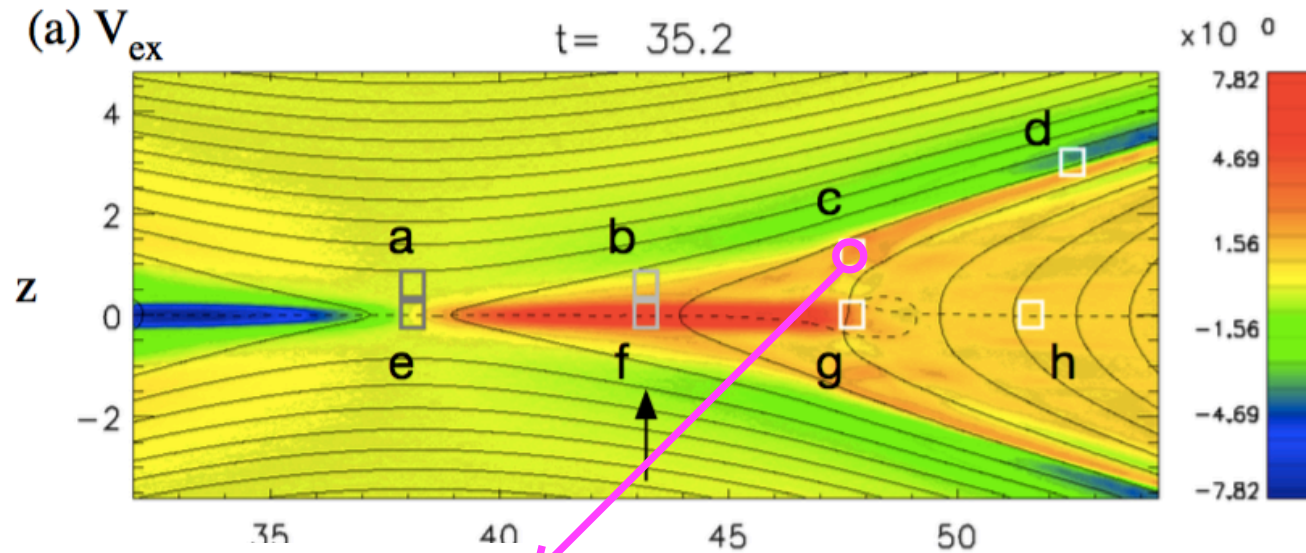

(c) $x=47.7$ $z=1.2$

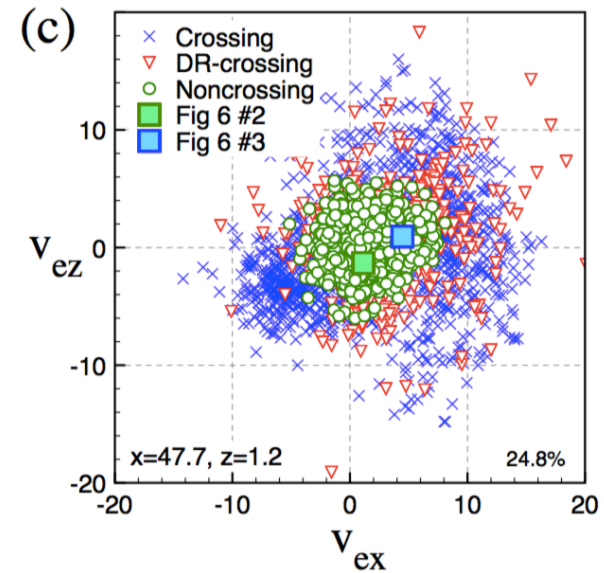
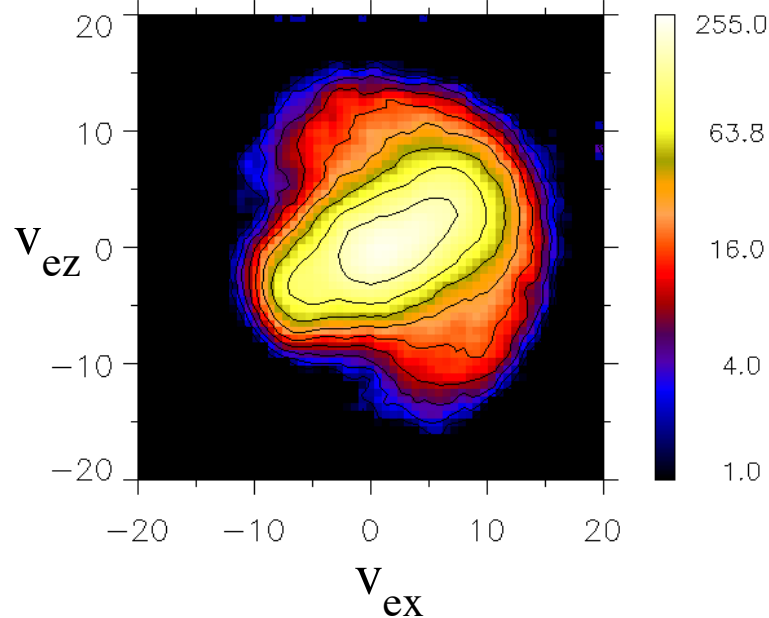

Spatial distribution of VDFs

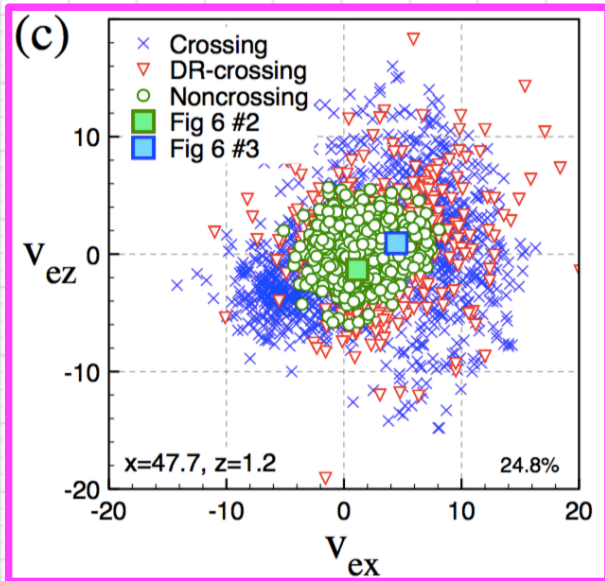

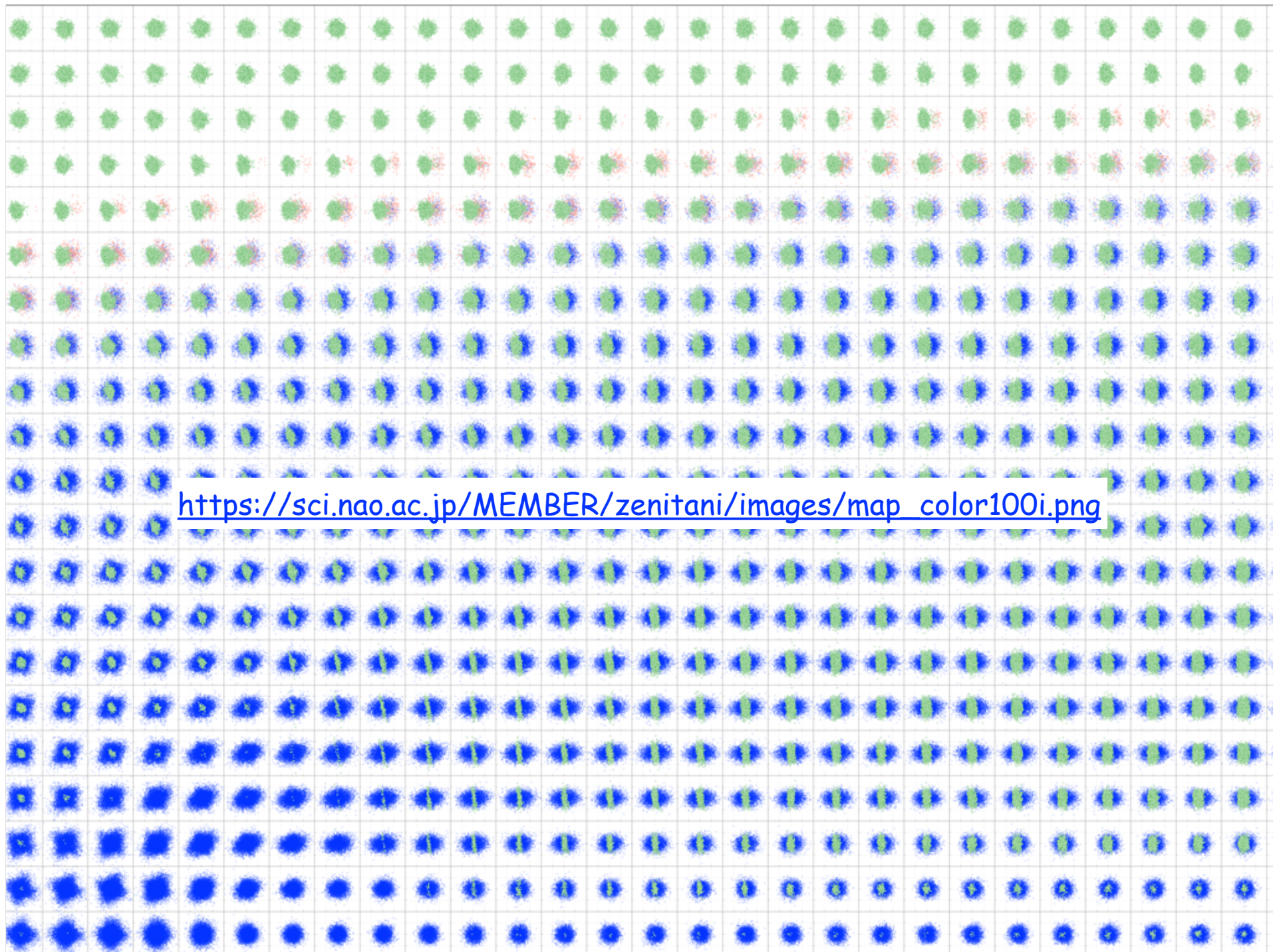

https://sci.nao.ac.jp/MEMBER/zenitani/images/map_color100i.png

Spatial distribution of Noncrossing electrons

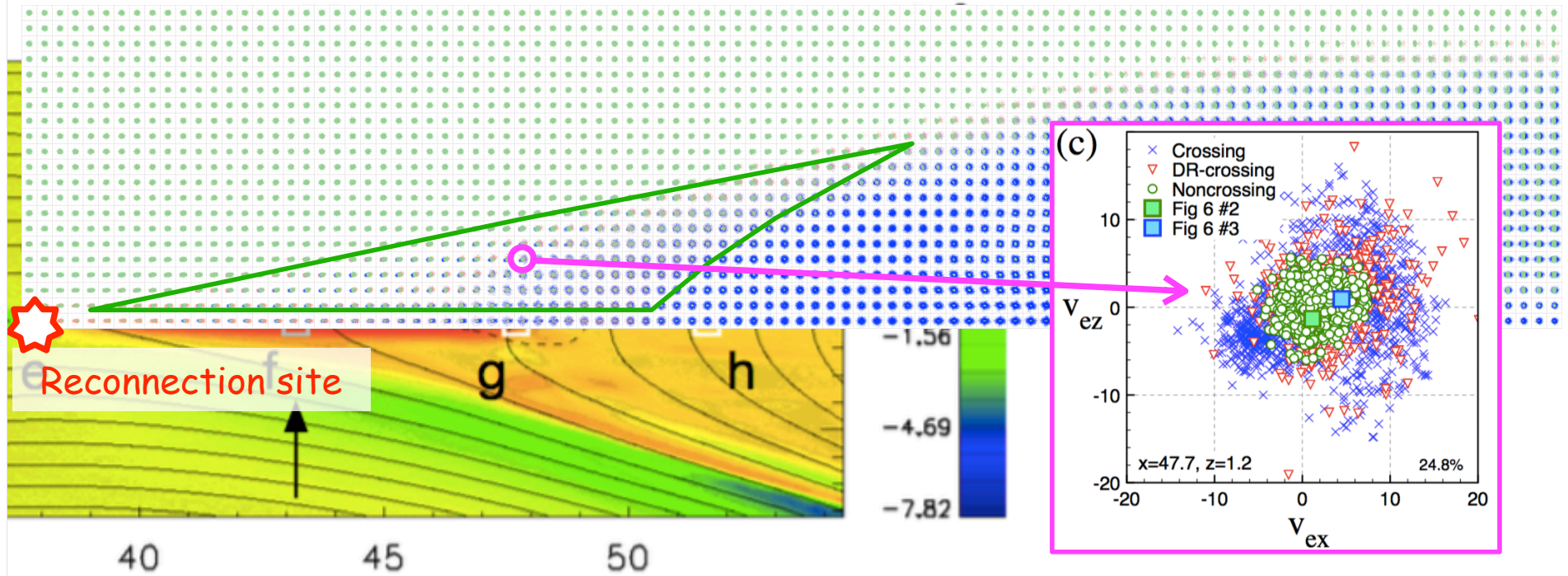

- Noncrossing electrons occupy a large area (surrounding the electron jets inside the ion diffusion region)
- They are **majority** in number

Noncrossing electrons: Majority in number

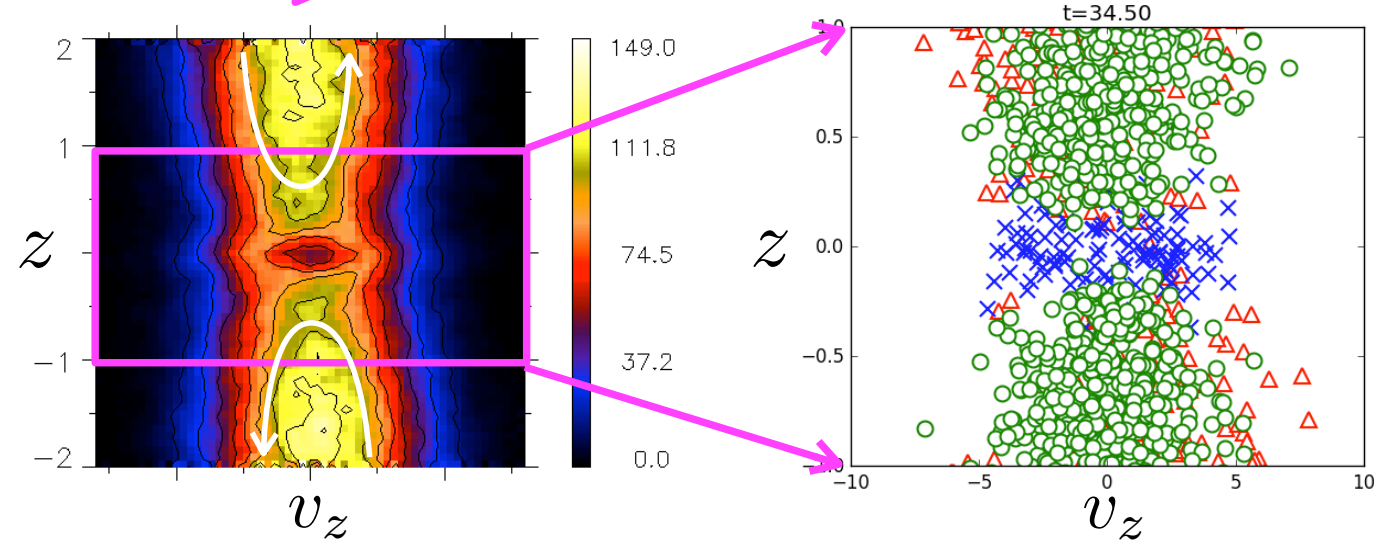
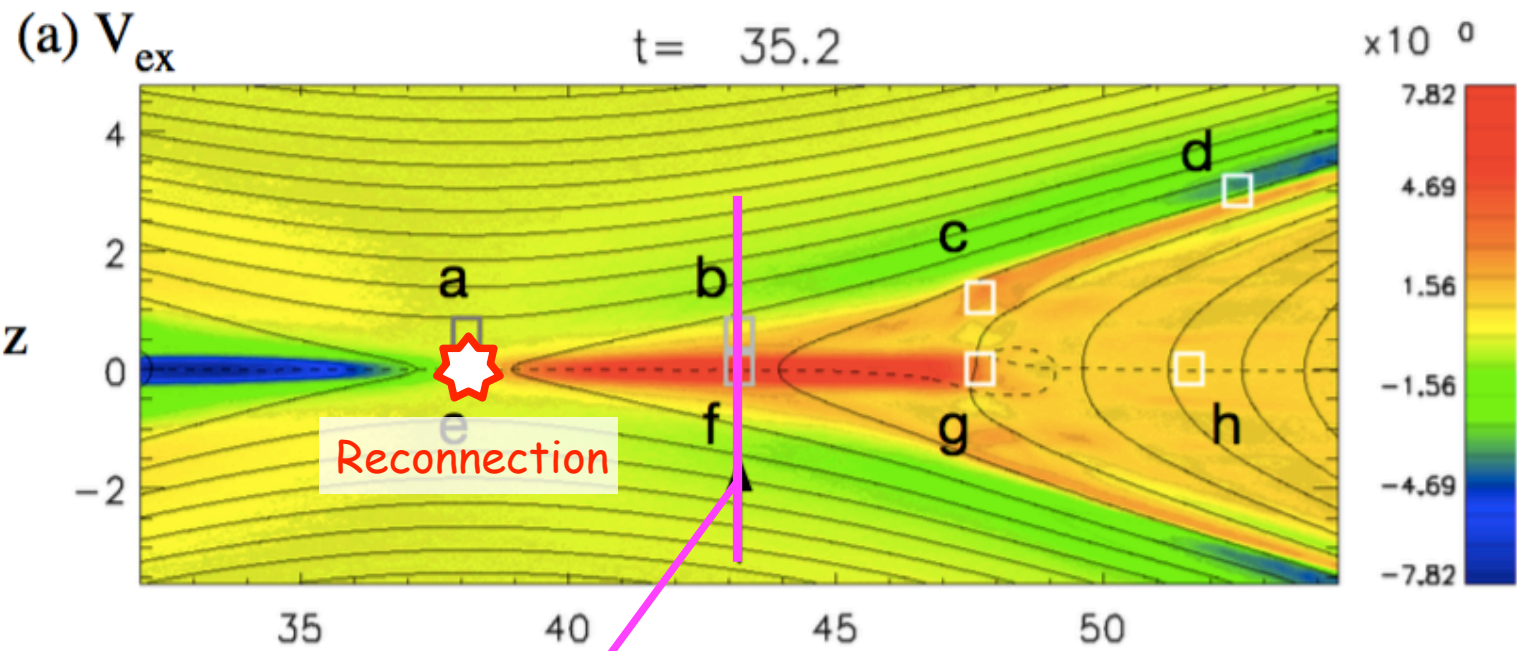

Summary

- 1. Particle motion in a reconnected geometry
 - Meandering orbit
 - Speiser orbit
 - Figure-8-shaped orbit
- 2. Ion motion and VDF in the outflow exhaust
 - Ion 8-shaped orbits
- 3. Electron motion around the reconnection site
 - Electron 8-shaped orbits
 - Noncrossing electrons -- They are majority
- References:
 - [1] Zenitani, Shinohara, Nagai, & Wada, *Phys. Plasmas* **20**, 092120 (2013)
 - [2] Zenitani & Nagai, *Phys. Plasmas* **23**, 102102 (2016)
 - [3] Zenitani, *J. Plasma Fusion Res.*, **97**, 47 (2021) [Tutorial article in Japanese]
http://www.jspf.or.jp/Journal/PDF_JSPF/jspf2021_02/jspf2021_02-47.pdf

More research needed!

- 1. Orbit theory
 - Influence of E_z
- 2. Ion 8-shaped orbit
 - Spatial distribution and the reason
 - Signatures of the Ion Diffusion Region (IDR)?
- 3. Noncrossing electrons
 - Signatures in VDFs
 - Influence to electron mixing
 - Two-fluid theory needs to be updated to three-fluid theory?
- Transition to the guide-field cases
- Influence of the 3-D structure
- ...

Thank you for your attention

Online VDF viewer

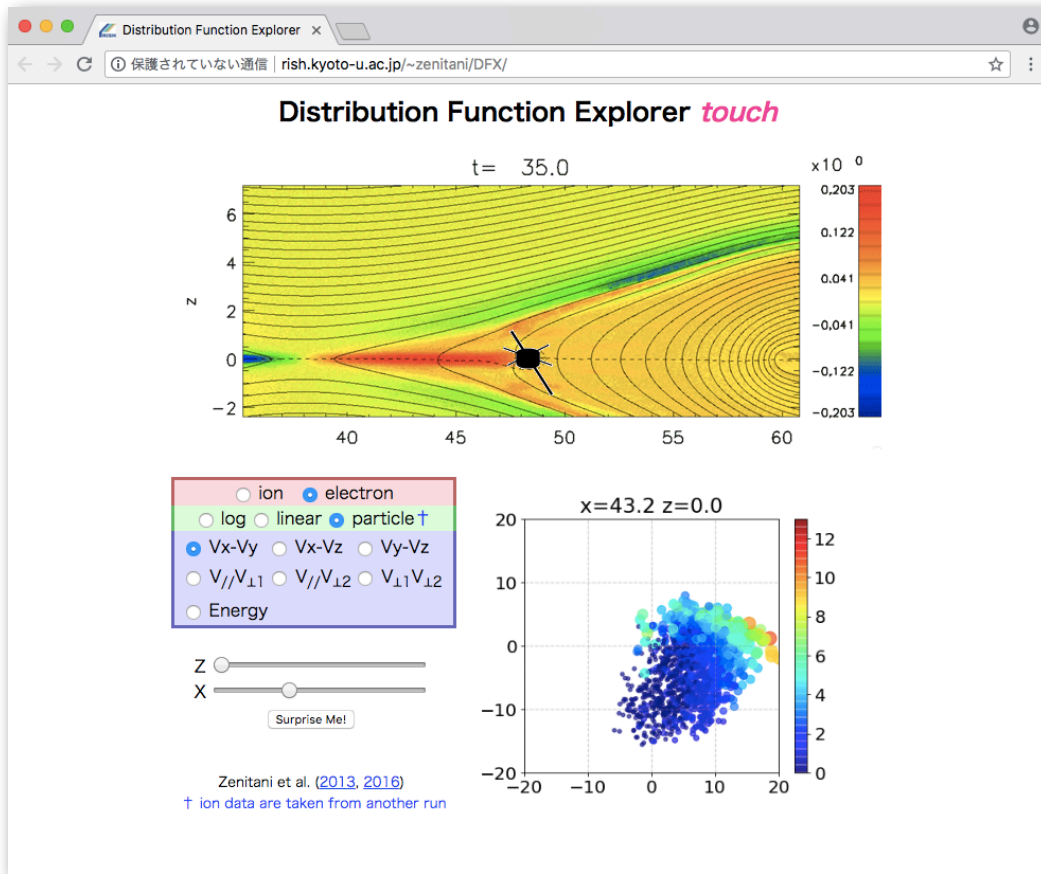

Touch our data on
your devices



<http://rish.kyoto-u.ac.jp/~zenitani/DFX/>